

2013

CITY OF REGINA

WATER AND SEWER UTILITY BUDGET

AS APPROVED BY CITY COUNCIL



Table of Contents

Letter of Transmittal

Introduction.....	1
Utility Operating Revenues	9
Utility Operating Expenditures	
Utility Operating Expenditures Summary	19
Water & Sewer Utility Description	24
Water.....	26
Wastewater	35
Drainage	38
Engineering and Operations Administration	43
Customer Billing and Collection	45
Debt Management	47
Utility Capital Program	
Capital Program Summary	49
Water Supply, Pumping and Distribution	52
Wastewater Collection and Treatment.....	55
Drainage	58
Utility Capital Funding.....	65

January 21, 2013

To: His Worship the Mayor,
and Members of City Council

Re: Water and Sewer Utility Budget

Each year City Council is required to adopt operating and capital budgets including the General Operating Budget, the Water and Sewer Utility Budget and the General Capital Budget. This document is the Water and Sewer Utility Budget, which includes the 2013 Utility Operating Budget and the 2013 – 2017 Utility Capital Budget.

Budget Highlights

- Utility rates for 2013 were adopted by City Council concurrently with the 2011 Water and Sewer Utility Budget. For a typical residential customer, the 2013 rates result in an 8.9% increase or about \$10 per month. The increase for a sample commercial customer is 8.9% or about \$65 per month.
- The overall revenue increase for 2013 is 9.3%. This reflects a 9% increase in utility rates, the impact of additional customers and reduced wastewater revenues resulting from process changes for an industrial customer. Details on the rates for 2011 through 2013 are provided on pages 12 and 13 of this document. In addition to the rate related increase, \$1.5 million is budgeted for a grant through the Saskatchewan Infrastructure Growth Initiative Program, as well as \$2 million to reflect the anticipated interest earned on Utility investments in 2013.
- The 2013 Utility Operating Budget provides the funding necessary to meet legislative requirements and Council's service objectives for water, wastewater and drainage. The total 2013 Operating budget for the Utility, excluding debt and the transfer to the general operating fund, is \$49.5 million, which is an increase of 8.0% from 2012. This increase is largely offset by a decrease in the expenditures required to service debt, resulting in a net operating budget in 2013 of \$61.0 million, a 0.8% increase from 2012. Cost increases in the operating budget largely arise from the increased cost of operating aging infrastructure. The Utility Operating Budget also provides for the continued development of asset management, business planning and performance metrics to achieve sustainable infrastructure investment strategies.
- The 2013 – 2017 Utility Capital Program totals \$398.6 million, with 2013 totaling \$39.0 million. In 2012, the total capital investment over the same five years and in 2013 were expected to be \$303.2 million and \$58.7 million respectively. The decrease in the projected expenditures for 2013 results from an assessment of the current progress and capacity of the Utility to manage and deliver the increased capital work demands. A reduced program will allow time for currently approved projects and programs to be delivered, as well as provide time to increase capacity through

retaining additional consultants and positions. The increase in the five year capital budget results from additional planning work being done in preparation for next year's rate review, which is consistent with issues that were identified in the 2010 rate review. The increase provides for projects and programs that were: missing or deferred within or beyond last year's financial model; operating transfers; or projects accelerated by developers to support the demands of growth.

- The 2013 – 2017 Utility Capital Budget proposes total debt of \$149 million by 2016 to meet these capital requirements. While the capital program for the next five years includes work on both the water and wastewater treatment plants as well as investing in approved development, and managing essential infrastructure work, the timing of debt issues will largely depend upon the construction schedule for the wastewater treatment plant.
- Each year an amount is transferred to the General Operating Fund, representing a payment in lieu of taxes and access fee. Any organization or utility operating in a municipality would be required to pay the municipality either property taxes or an access fee for operating rights. Regina's transfer is the total of 7.5% of the previous year's budgeted revenues for billed water consumption, wastewater charges and drainage infrastructure levy plus an amount (\$675,000) estimated to be 3/7ths of the GST rebate received by the Utility. This amount is the additional rebate provided by the Federal Government starting in 2004. For 2013, these budgeted amounts total \$7.4 million.

Public Reporting

In 2005, the Province adopted new regulations in Part V.1 of *The Cities Regulations* regarding Public Reporting on Municipal Waterworks. The regulations apply only to waterworks, however since the Utility includes water, wastewater and drainage services, the information required by the regulations is provided for the entire utility. The information requirements include:

- Information on the rate policy and capital investment strategy as adopted pursuant to sections 22.3 and 22.4 of the regulations. The information required with respect to the City's rate policy is provided on pages 10 through 13 of this document. Information on the capital investment strategy is included in the Utility Capital Program Section of this document and in particular, the Infrastructure Overview Section starting on page 49.
- A financial overview providing the information outlined in the regulations. The data outlined in the regulations is included in the Introduction Section of this document on page 1. More detailed information on the revenues and expenditures is provided in the detailed Utility Revenue and Utility Expenditure sections. The regulations also require a comparison of the Utility revenues to expenditures and debt payments, expressed as a ratio in accordance with the following formula:

$$\frac{\text{Revenues}}{\text{(Expenditures + Debt Payments)}}$$

For 2013, based on the definitions in the regulations, the ratio for the Water and Sewer Utility is 1.92, based on revenues of \$102,889,800, expenditures of \$52,160,100 and debt repayments of \$1,506,000. In accordance with the definition in the regulations, expenditures include the interest cost on the debt, while debt payments are the principal repayments on the debt.

For 2013, the ratio indicates that revenues exceed expenditures and debt repayments by 92%. This is a positive result that indicates the Utility is recovering its operating costs as well as providing investment for future capital requirements. In 2014, this ratio will drop to 1.10 due to the repayment of debt taken through the provincial SIGI program. After 2015, the ratio is projected to increase to approximately 2.0 over the next several years as additional funding is generated to fund large capital projects such as the Wastewater Treatment Plant Expansion, along with on-going requirements such as infrastructure investment.

- Information on the current reserves and deferred revenue, capital plans for infrastructure projects and the sources of funding for the capital projects are detailed in the Utility Capital Program section of this document.

Capital Requirements and Funding

Regina's location, in a sensitive natural environment far from a major water source, affects the standards and costs for water supply and wastewater treatment and disposal. Additional information on the Utility services and systems in Regina is provided in the Introduction and Expenditure Sections of this document and in the Water and Sewer Utility Business Plan.

The 2013 Utility Capital Budget totals \$39.0 million with the 2013 – 2017 Utility Capital Budget totaling \$398.6 million over five years. The proposed five-year capital program is approximately \$95.4 million more than the five-year capital program approved in 2012; an increase of about 31.5%. The 2013 program is smaller than the 2012 program to ensure sufficient time and resources are put in place to effectively and responsibly manage the existing and proposed capital programs and budgets largely because of a more focused effort to manage the completion of funded projects that are in progress. The five year program, conversely, has grown from the 2012 five year program because the 20 year capital model was rebuilt as part of the 2013 budget process. While these are significant expenditures, they are not unreasonable considering recent construction cost escalations, and that the estimated replacement cost of the entire system exceeds \$3.5 billion.

While the capital investment proposed for 2013 to 2017 is significant, the long term requirements of the system will continue to put pressure on rate and debt requirements. The capital program for the next five years is focused on addressing the need to upgrade plants, invest in approved development, and manage essential infrastructure work, including the collection of infrastructure condition data to support sound decision making and the implementation of industry best asset management practices.

While the 20 year Utility Model has been improved to include a number of projects and investments that were not quantified or included in past models, the proposed model is still founded on some conservative or optimistic assumptions regarding the timing and cost of a number of projects, and it still does not include incremental investments that may be needed to support the new Official Community Plan, redevelopment projects or additional reductions in green house gas emissions. The assumptions create some risks for the City, particularly in relation to the amount of debt that is expected or may be required, particularly in relation to the borrowing capacity and other needs of the City.

Capital requirements include an expansion to the Wastewater Treatment Plant to meet the Federal Government requirements under The Canadian Environmental Protection Act and The Fisheries Act as well as to comply with Saskatchewan Environment Regulations. Improvements are also required under

the Provincial Water Quality Standards. The capital cost of this work, based on the value at the mid-point of construction in 2015, is expected to be \$207 million. In addition to the regulatory requirements, numerous components of the plant require replacement or refurbishment. While Utility rates were increased in 2008 – 2010 and again in 2011 – 2013 to begin to address these and other capital pressures, the timing and magnitude of the increased revenue is insufficient to offset the timing and financial impact associated with such regulatory changes and other ongoing capital requirements.

Maintenance of the water, wastewater and drainage systems is a duty of the City in the interest of public health and safety. Aging infrastructure and changing regulatory standards contribute to the increasing need for revenue, which result in a requirement to increase rates. The City has a duty to be responsible stewards of these essential utilities to ensure regulatory compliance, and to promote the health, well being and economic prosperity of the community.

Respectfully submitted,



Glen B. Davies
City Manager

Introduction

Introduction

Utility Operating Budget Summary (\$000's)

Details (\$000's)	2012 Budget	2012 Actual	2013 Budget	Budget Change	
				Dollar Change (\$)	Percent Change (%)
Operating Revenue:					
Water	45,931.1	47,923.6	50,346.8	4,415.7	9.6
Wastewater	34,731.1	35,017.7	36,088.0	1,356.9	3.9
Drainage	10,775.5	10,883.3	11,906.6	1,131.1	10.5
Other	4,118.4	4,062.9	4,548.4	430.0	10.4
Total Operating Revenue	95,556.1	97,887.5	102,889.8	7,333.7	7.7
Operating Expenditures:					
Water, Wastewater & Drainage Operations and Construction	24,409.0	24,774.8	25,256.0	847.0	3.5
Wastewater Treatment	6,228.4	6,300.0	7,869.6	1,641.2	26.4
Engineering and Operations	7,035.4	6,134.6	7,679.4	644.0	9.2
Utility Administration	8,132.8	8,017.8	8,680.0	547.2	6.7
Access Fees	6,881.2	6,881.2	7,380.9	499.7	7.3
Total Operating Expenditures	52,686.8	52,108.4	56,865.9	4,179.1	7.9
Other Expenditures:					
Debt Costs	41,479.4	7,888.7	4,181.1	(37,298.3)	(89.9)
Total Expenditures	94,166.2	59,997.1	61,047.0	(33,119.2)	(35.2)
Net Utility Reserve Transfer	33,590.7	37,890.4	41,842.8	8,252.1	24.6

2013 Budget Overview

The 2013 Water and Sewer Utility Operating and 2013 – 2017 Utility Capital Budgets reflect Regina's commitment to maintaining safe and secure Utility operations. Across North America, water and sewer rates are increasing as utilities face challenges relating to:

- assessment and replacement of aging infrastructure
- expansion of capacity
- improvements required to meet enhanced and/or more stringent regulations and standards.

The 2013 – 2017 Utility Capital Program totals \$398.6 million, with 2013 totaling \$39.0 million. In 2012, the total capital investment over the same five years and in 2013 were expected to be \$303.2 million and \$58.7 million respectively. The decrease in the projected expenditures for 2013 results from an assessment of the current progress and capacity of the Utility to manage and deliver the increased capital work demands, which have increased substantially over the past number of years and are expected to continue at this level for the foreseeable future. A reduced program will allow time for currently approved projects and programs to be delivered, as well as provide time to increase capacity through retaining increased consultants and positions.

The increase in the five year capital budget results from additional planning work that is being done in preparation for next year's rate review, which is consistent with issues that were identified in the 2010 rate review. The increase provides for projects and programs that were: missing or deferred within or beyond

last year's financial model; operating transfers; or projects accelerated by developers to support the demands of growth.

While the capital investment proposed for 2013 – 2017 is significant, the long term requirements of the system will continue to put pressure on rate and debt requirements. The capital program for the next five years is focused on addressing the need to upgrade plants, invest in approved development, and manage essential infrastructure work, including collecting infrastructure condition data to support future decisions.

Capital requirements include an expansion to the Wastewater Treatment Plant to meet the Federal Government requirements under *The Canadian Environmental Protection Act* and *The Fisheries Act* as well as to comply with Saskatchewan Environment Regulations. Improvements are also required under the Provincial Water Quality Standards. The capital cost of this work, based on the value at the mid-point of construction in 2015, is expected to be \$207 million. In addition to the regulatory requirements, numerous components of the plant require replacement or refurbishment. While Utility rates were increased in 2008 – 2010 and again in 2011 - 2013 to begin to address these and other capital pressures, the timing and magnitude of the increased revenue is insufficient to offset the timing and financial impact associated with such regulatory changes and other ongoing capital improvements.

In 2013, the Utility has budgeted for \$1.465 million in provincial grant revenue from the Saskatchewan Infrastructure Growth Initiative Program (SIGI). This revenue is equivalent to the debt servicing cost for \$43.1 million in debt financing originally provided by the SIGI Program to finance the Global Transportation Hub. This funding was transferred to the Utility in 2010.

In 2013, after the 9% increase, the price of a cubic metre of water will be \$1.47. This volume of water is equivalent to two thousand 500 millilitre bottles, which would cost at least \$3,000.

2013 Budget Process

The budget process always involves difficult choices. A key aspect of the budget process is that City Council is making choices on behalf of the community. With the limited resources available, it is important that each year's budget process involve the establishment of priorities. Many Canadian cities are developing multi-year strategic plans to help guide the resource allocation process. Building on the strength of work carried out over the past few years, the 2013 budget was developed based on priorities established through City Council's Vision for Regina, the Corporate Strategic Plan and an assessment of future issues and opportunities faced by the organization.

The approach to developing the 2013 Budget focused on identifying strategic priorities and allocating resources to those priorities to avoid having budget limitations drive the strategy. Divisions identified requirements for ongoing and one-time initiatives and evaluated them according to the strategic priorities. Divisions also identified opportunities where existing resources could be reallocated toward the strategic priorities.

Corporate Strategic Planning and Performance Management Process

City Council has adopted the following Vision for Regina:

Canada's most...
Vibrant,
Inclusive,
Attractive,
Sustainable community
Where people live in Harmony
And Thrive in opportunity.

To achieve the vision the City has established an accountability framework. This framework demonstrates that both Council and the administration have a role in strategic planning – Council sets the Vision, the administration develops strategic and business plans to align their activity to the Vision.

City of Regina Accountability Framework



Corporate Strategic Plan

While the Vision identifies the long term direction for the City of Regina, in order to achieve the Vision, a number of challenges have to be addressed in the short term. In 2012 and again for 2013, within the context of the Vision, the City of Regina has focused on the issue of financial sustainability.

Administration has developed the short-term strategic focus, *“that we will have narrowed the gap between current and expected service levels and our ability to deliver them.”* This focus recognizes that the current resources available to the City do not support the sustainable delivery of the current portfolio of services at the current level. Administration is considering areas where services can be reduced or eliminated, where revenues can be increased and where services can be delivered in different ways to improve their

affordability. In 2013, the City will be consulting with citizens to more fully understand their expectations, including the trade-offs they are prepared to make to maintain the most important services.

Perhaps the most urgent issue related to the financial sustainability of the City of Regina is the issue of infrastructure. In an effort to maintain affordable services for Regina taxpayers, the City of Regina (similar to most other municipalities in Canada) has chosen to defer on-going life-cycle maintenance and renewal of infrastructure. The issue has reached a critical point where deferral could result in service or infrastructure failures.

Council endorsed the strategic focus and its key deliverables in March, 2012. The Administration has developed a performance measurement system to support the new strategic focus and has cascaded accountabilities for results throughout the organization.

One of the key issues that is being addressed by the strategic focus is the resourcing of infrastructure renewal. The strategy has created the capacity to move additional resources to respond to this pressing gap. In the 2012 budget, by managing or reducing costs in other areas, the City was able to increase its tax-funded investment in infrastructure by 32%. The City is working to achieve another significant increase in this investment in 2013.

During 2013, the City of Regina will be developing a strategic plan for the 2014-2017 period. The scope of this plan will incorporate the strategic focus of 2012 and 2013 but will be broadened to more fully respond to the Vision and the Community Priorities that were identified as part of the Design Regina process.

Business Planning

As part of the strategy development, targets were cascaded throughout City of Regina divisions and departments. Divisional and departmental business planning used the corporate targets as a basis for planning. In addition to this “top-down” approach, Divisions also incorporated their knowledge of customer and citizen priorities, facility and infrastructure requirements, and their daily analysis of risks and opportunities resulting from ongoing operations – a more “bottom-up” approach. The two approaches working together ensure that the corporate strategic approach will integrate into Divisional and departmental business plans that are both strategic and responsive.

As planning cascades through the organization, the level of engagement and detail will become increasingly refined. Participants in the planning sessions are cross functional to ensure an integrated approach and a ‘de-siloing’ of the organization.

Some areas within the City of Regina have undertaken business planning in the past. What is new for these groups is that they now have a longer term corporate Vision, Mission, Values and Strategic Directions to provide better context for their planning efforts.

In 2010, the first Water and Sewer Utility Business Plan was documented to capture the current state of the Utility business and outline how the Utility supports the City’s goals. This plan also established the foundation for ongoing evolution and improvement of the Utility business. The Water and Sewer Utility: 2010-2011 Business Strategy, along with the Corporate Strategic Plan and pertinent Division and Department business plans, guided the development of the 2013 Utility Budget.

2013 Strategic Focus and Business Improvement Strategy

In line with the City strategy, the Utility has identified Asset Management as its approach to help narrow the gap and set the stage for continued high performance and sustainability. Asset Management (AM) is a way of doing business that ensures we invest our resources wisely over the long term by continually balancing

performance, risk, and expenditures in a way that ensures we meet customer service levels and effectively and efficiently achieve our organizational strategic plan.

The Utility has received approval for 9% rate increases from 2008 -- 2013 but it is recognized that such increases may be unsustainable over the longer term. Thus, beyond the larger City initiative to “narrow the gap”, the Utility must ensure that it is operating as efficiently and effectively as it can while responding to customer expectations appropriately. Through the development of a comprehensive business improvement strategy (through the filter of AM), the Utility will be better able to quantify the required renewal and investment programs and better understand the linkage between investment and the customer outcomes it delivers. This strategy will allow the Utility to understand and demonstrate the value that it is providing for money to customers. Any rate increases beyond 2013 will be based on performance based information and linked to customer outcomes.

The Utility retained CH2M HILL Canada Ltd. (CH2M HILL) to provide consulting support for the design and planning of this project. The study focused on the three Divisions that make up the Utility: Planning & Development, Public Works and Corporate Services. The objectives of the study were to work with Utility staff to understand the current situation with respect to asset management performance and to develop a Roadmap to improve Utility management and performance. The Roadmap has guided the work of the Utility throughout 2012 and will continue to identify the priority initiatives of the AM project plan, known as the Business Improvement Strategy. The business improvement strategy will provide the foundation for the 2013 Rate Review, which will be the basis for Utility rate setting for the next 4 year period.

Utility Service Overview

The Water and Sewer Utility provides water, wastewater and drainage services primarily to customers in Regina. The services provided through the Utility include:

- **Water Supply, Pumping and Distribution**

The water system provides water for residential, institutional, commercial and industrial customers as well as water for fire protection. The system serves a population of approximately 200,000 including some customers outside the City limits. Service goals include:

- Providing water that meets or exceeds Provincial water quality standards and objectives.
- Providing water at adequate pressure and in sufficient quantity to satisfy the requirements for domestic and commercial use, irrigation and fire protection.
- Identifying and implementing improvements to the water system through long range planning, monitoring, improved operation, capital works and new technology.
- Participating in Communities of Tomorrow and National Research Council's Centre for Sustainable Infrastructure Research to develop new technologies and improve practices.

- **Wastewater Collection and Treatment**

The wastewater system collects wastewater from all residential, institutional, commercial and industrial customers in the City, and treats wastewater to meet Provincial and Federal environmental regulations and industry standards. Service goals include:

- Collecting domestic, commercial and industrial wastewater in the City and reliably delivering it to wastewater treatment facilities.

- Producing a treated wastewater effluent that is biologically and chemically safe for the environment and meets the requirements of the provincially issued operating permit.
- Ensuring pollutants removed from the wastewater are treated and disposed of in an environmentally responsible manner.

- **Drainage**

The drainage system controls water runoff resulting from rainfall and melting snow in and around the city. The system serves approximately 65,000 residential, institutional, commercial and industrial properties. Service goals include:

- Operating and maintaining the drainage system to control run-off water within the city to minimize inconvenience, property damage and danger to the public.
- Monitoring the potential for flood conditions in Wascana Creek and the storm channels and carrying out flood control measures as required.
- Providing environmental monitoring of storm water quality.

The Water and Sewer Utility is responsible for diverse infrastructure including water mains, storage reservoirs, pumping stations, building service connections, wastewater treatment plant, wastewater and storm drainage sewers, and drainage channels and creeks. The City of Regina is also a joint owner of the Buffalo Pound Water Treatment Plant with the City of Moose Jaw.

Regional Setting

Regina is the centre of an economic region comprised of approximately 40 communities. Initiatives are underway to strengthen partnerships and to collaborate on mutual opportunities and interests. Regina's Utility systems provide some regional services and over time their role may increase. Regina's landlocked status is unique among major Canadian cities and impacts the standards and costs for water supply and wastewater treatment and disposal.

The Utility's water supply and wastewater treatment systems are intended to provide treatment that is appropriate to its natural setting and to minimize the city's influence on the receiving environment and its downstream neighbours. Regina's water supply originates with snow melt and rainfall in the eastern Rocky Mountains that feed the tributaries of the South Saskatchewan River. Buffalo Pound Lake is the source of treated water for Regina, Moose Jaw and several surrounding communities. Regina's treated wastewater effluent and stormwater run-off ultimately end up in Wascana Creek, a seasonal stream that originates to the east of Regina and flows through the City. For much of the year these sources are the only water that feeds Wascana Creek, and without these sources, the creek would be dry.

Regulatory Environment

Saskatchewan Watershed Authority is responsible for management of Saskatchewan's surface water and ground water resources. The Authority regulates the allocation of water, establishes management plans for the province's river basins and is responsible for land drainage and wetland preservation and enhancement.

Saskatchewan's Ministry of Environment regulates water supply and distribution, and wastewater collection, treatment and disposal. Permits for the construction and operation of water and wastewater systems require specific standards to protect human health, to ensure consistent water quality, and to minimize impacts on the natural environment. Requirements outlined in the provincial regulations include mandatory operator certification, routine facility inspections, testing and reporting to ensure compliance.

The Federal Government's Fisheries Act prohibits the discharge of any "deleterious substance" that may affect fish or fish habitat. Ammonia is designated a "toxic" substance that is part of the federal governments proposed national standards to regulate municipal wastewater effluents. The Utility's wastewater treatment plant (WWTP) requires a capital upgrade to meet the acute toxicity requirement.

The provinces may impose additional regulations beyond the federal requirements and the Province of Saskatchewan does require the Utility to meet standards beyond the proposed federal standard. Utility staff and Saskatchewan Ministry of Environment are in broad agreement on the principle that treated effluent standards for the Utility's upgraded wastewater treatment plant should consider environmental effects in the downstream environment. To address this principle, the Utility continues to carry out a significant monitoring program to document current conditions and help project future conditions in the downstream environment as well as initiating engineering for the WWTP upgrade. Should the Province decide to make standards even more stringent, further significant capital costs would be required. The Utility supports the principle of shared fiscal responsibility with respect to protection of the environment. Currently, no provincial or federal funding is provided to meet increased regulatory standards.

It is recognized that the Utility, in particular pumping and treatment operations, accounts for approximately 50% of the corporation's overall GHG emissions. The feasibility of alternatives and associated costs are being considered to achieve reductions that are largely realized by decreasing energy consumption or changing the energy source. Energy consumption is a key consideration in the development of the wastewater treatment plant upgrade.

This page left blank intentionally.

Utility Operating Revenues

Utility Operating Revenues

Utility Operating Revenue Summary (\$000's)

Revenue Details (\$000's)	2012 Budget	2012 Actual	2013 Budget	Budget Change	
				Dollar Change (\$)	Percent Change %
Water Revenue					
Metered Water Charges	45,395.1	46,707.1	49,810.8	4,415.7	9.7
Unmetered Water Charges	50.0	37.5	50.0	-	-
Service Connections (New/Replacement)	486.0	1,179.0	486.0	-	-
Subtotal	45,931.1	47,923.6	50,346.8	4,415.7	9.6
Wastewater Revenue					
Wastewater Charges	33,241.2	34,655.1	35,988.0	2,746.8	8.3
Wastewater Service Surcharge	100.0	362.6	100.0	-	-
Subtotal	33,341.2	35,017.7	36,088.0	2,746.8	8.2
Drainage Infrastructure Levy	10,775.5	10,883.3	11,906.6	1,131.1	10.5
Other Revenues:					
Provincial Grant - SIGI	1,465.4	1,465.4	1,465.4	-	-
Interest Earned on Investments	1,600.0	1,637.0	2,000.0	400.0	25.0
Account Service Fees	280.0	363.8	300.0	20.0	7.1
Delinquency & Collection Admin.	257.0	266.2	267.0	10.0	3.9
Meter Administration Fees	105.0	53.7	105.0	-	-
SAF Administration Fees	384.0	-	384.0	-	-
Other Revenues	27.0	276.8	27.0	-	-
Subtotal	4,118.4	4,062.9	4,548.4	430.0	10.4
Total Utility Revenues	94,166.2	97,887.5	102,889.8	8,723.6	9.3

Use of 2013 Utility Revenue

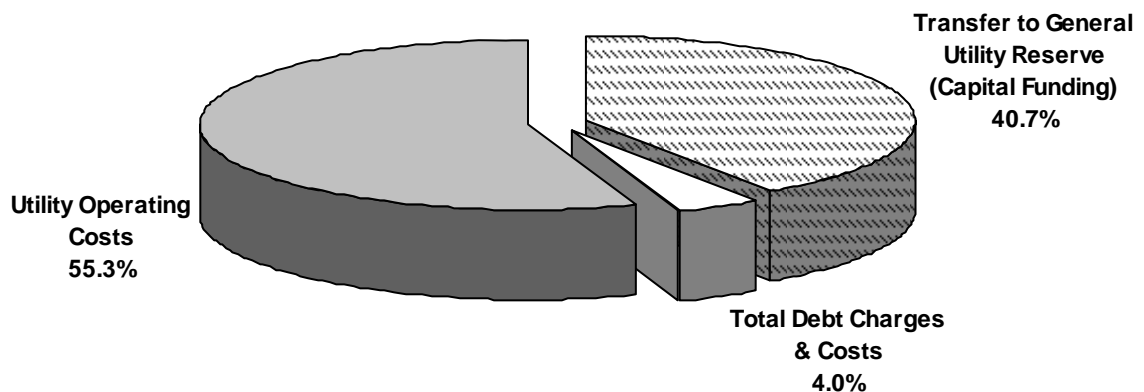

Utility Rates and Rate Policies

Section 22.3 of *The Cities Regulations* requires Council to adopt a rate policy that sets out the rates or fees to be charged to consumers for the use of water. The policy must include the method used to determine those rates or fees. In establishing Utility rates, the following policies have been adopted in the past by City Council:

1. Utility rates are to be established such that they are sufficient, based on long term projections, to fully fund Utility operating costs, interest cost and debt repayments, capital requirements, and transfer policies, taking into account the operating and infrastructure requirements of the Utility required to meet the service goals of the Utility, as determined by City Council or prescribed by legislation. The objectives for the Utility's rate structure are:
 - **Financial Self Sufficiency** – Utility rates must generate revenue adequate to meet all operating and capital costs of the Utility in both the short and the long term.
 - **Conservation** – Utility rates should encourage customers to use water responsibly.
 - **Reduction of Peak Demand** – The Utility rates should encourage water conservation during summer months, reducing the need for infrastructure investment and higher rates.
 - **Equity** – The Utility rates should result in a charge to customers according to the cost of services utilized.
2. The rate structure for water and wastewater will include a base fee that varies according to the size of the water meter. The variation in the base rate by meter size will be based on the schedule recommended by the American Water Works Association (AWWA). The ratios for the base rate based on meter size are shown in the following table.

Water and Wastewater Base Fee Ratios

Meter Size	AWWA Standard Ratio
15 mm	1.0
18 mm	1.0
25 mm	1.4
40 mm	1.8
50 mm	2.9
75 mm	11
100 mm	14
150 mm	21
200 mm	29

3. The rate structure for water and wastewater will include a uniform rate for each cubic metre of water consumed and each cubic metre of deemed wastewater flow. For water, the uniform rate is applied to all consumption. For wastewater, the deemed volume is a percentage of the water consumption. The percentages are:
 - For residential customers, the wastewater volume is 82% of the water consumption;
 - For multiple unit residential properties, the percentage is 95% of the water consumption; and,
 - For institutional, commercial and industrial properties, the percentage is 98% of the water consumption.

4. The rate structure for the storm drainage infrastructure levy will be based on the size of the property, with larger properties paying a higher levy. The ratios approved by City Council in 2001 (CR01-189) are shown in the following table. The drainage levy applies irrespective of whether the property is connected to the water or wastewater systems.

Drainage Infrastructure Rate Ratios

<u>Area of Property</u>	<u>Rate Ratio</u>
0 to 1,000 m ²	1.0
1,001 to 3,000 m ²	2.0
3,001 to 5,000 m ²	4.0
5,001 to 7,000 m ²	6.0
7,001 to 9,000 m ²	8.0
9,001 to 11,000 m ²	10.0
11,001 to 13,000 m ²	12.0
13,001 to 15,000 m ²	14.0
15,001 to 17,000 m ²	16.0
17,001 to 19,000 m ²	18.0
19,001 to 21,000 m ²	20.0
21,001 to 23,000 m ²	22.0
23,001 to 25,000 m ²	24.0
25,001 to 27,000 m ²	26.0
27,001 to 29,000 m ²	28.0
29,001 to 31,000 m ²	30.0
Over 31,000 m ²	32.0

Regardless of actual property size, the rate for properties up to 1,000 m² is applied to all locations designated as “standard residential properties.”

5. **In the setting of rates, the Utility must at minimum present a balanced budget**, with any surplus intended for the following purposes:

- **Transfer to the General Utility Reserve** –The purpose of the reserve is to provide a source of financing for capital projects and to provide a contingency to fund emergency expenditures. The balance of the Utility’s surplus, after other transfers, is transferred to the General Utility Reserve. For 2013, the transfer is budgeted at **\$41.8 million**. Through the use of the Utility Model, an overall requirement for capital funding is established. Utility rates are set in order to provide sufficient surpluses to cover the capital costs over the next twenty years.

In the event that the Utility incurs an operating deficit in a given year, the deficit would also be funded from the reserve.

6. **The Utility Operating Expenses also include an ‘Access Fee,’ which is a transfer to the City’s General Operating Fund.** Any organization or Utility operating in a municipality would be required to pay the municipality either property taxes or an ‘Access Fee’ for the rights to use or access civic assets in the delivery of service. Policies on these types of fees vary from city to city. Calgary’s Utility pays 10% of revenue plus a 10% return on equity. The City of Saskatoon’s Utility pays a franchise fee based on 10% of revenue. Winnipeg’s is also 10%, with dividends paid. Moose Jaw’s rate is 5% of revenue. Regina’s transfer is the total of the following amounts:

- 7.5% of the previous years budgeted revenues for billed water consumption, wastewater charges and drainage infrastructure levy; and,

- The amount of \$675,000, estimated to be 3/7^{ths} of the GST rebate received by the Utility. This amount is the additional rebate provided by the Federal Government starting in 2004.

For 2013, these amounts total \$7.4 million.

City Council's practice has been to establish Utility rates every three years, with a three-year schedule of rates adopted. Rates for water, wastewater and drainage for 2011 - 2013 were approved in conjunction with the 2011 Utility Budget.

The approved Utility rates for 2011 through 2013 are shown in the following tables. Rates are billed monthly and are based on a daily fixed charge.

Water Rates

	<u>Approved Rate Schedule</u>		
	<u>2011 (\$)</u>	<u>2012 (\$)</u>	<u>2013 (\$)</u>
Daily Base Fee:			
15 mm/18 mm water meter	0.52	0.57	0.62
25 mm water meter	0.73	0.80	0.87
40 mm water meter	0.94	1.03	1.12
50 mm water meter	1.51	1.65	1.80
75 mm water meter	5.72	6.27	6.82
100 mm water meter	7.28	7.98	8.68
150 mm water meter	10.92	11.97	13.02
200 mm water meter	15.08	16.53	17.98
Volume Charge:			
Charge per m ³	1.24	1.35	1.47

Wastewater Rates

	<u>Approved Rate Schedule</u>		
	<u>2011 (\$)</u>	<u>2012 (\$)</u>	<u>2013 (\$)</u>
Daily Base Fee:			
15 mm/18 mm water meter	0.40	0.44	0.48
25 mm water meter	0.56	0.62	0.67
40 mm water meter	0.72	0.79	0.86
50 mm water meter	1.16	1.28	1.39
75 mm water meter	4.40	4.84	5.28
100 mm water meter	5.60	6.16	6.72
150 mm water meter	8.40	9.24	10.08
200 mm water meter	11.60	12.76	13.92
Volume Charge:			
Charge per m ³	1.11	1.21	1.32

Storm Drainage Rates

Daily Base Fee	Approved Rate Schedule		
	2011 (\$)	2012 (\$)	2013 (\$)
0 to 1,000 m ²	0.35	0.38	0.41
1,001 to 3,000 m ²	0.70	0.76	0.82
3,001 to 5,000 m ²	1.40	1.52	1.64
5,001 to 7,000 m ²	2.10	2.28	2.46
7,001 to 9,000 m ²	2.80	3.04	3.28
9,001 to 11,000 m ²	3.50	3.80	4.10
11,001 to 13,000 m ²	4.20	4.56	4.92
13,001 to 15,000 m ²	4.90	5.32	5.74
15,001 to 17,000 m ²	5.60	6.08	6.56
17,001 to 19,000 m ²	6.30	6.84	7.38
19,001 to 21,000 m ²	7.00	7.60	8.20
21,001 to 23,000 m ²	7.70	8.36	9.02
23,001 to 25,000 m ²	8.40	9.12	9.84
25,001 to 27,000 m ²	9.10	9.88	10.66
27,001 to 29,000 m ²	9.80	10.64	11.48
29,001 to 31,000 m ²	10.50	11.40	12.30
Over 31,000 m ²	11.20	12.16	13.12

Utility Customers

The Utility provides services to a population of approximately 200,000 including service to some customers and communities outside of the City limits. The following tables provide information on the number and categories of Utility customers.

Water and Sewer Utility Customers

	Water Customers	Wastewater Customers	Drainage Customers
Residential	60,783	60,773	60,975
Multi-Unit Residential	848	846	825
Commercial	3,221	3,082	3,298
Irrigation	165	38	-
Total	65,017	64,739	65,098
Within City Limits	64,932	64,701	65,098
Outside City Limits	85	38	-
Total	65,017	64,739	65,098

Water Customers

Water	Residential	Multi-Unit Residential	Commercial	Irrigation	Total
15 mm - 5/8"	57,933	22	1,230	11	59,196
18 mm - 3/4"	2,696	223	1,065	20	4,004
25 mm - 1"	142	362	415	58	977
40 mm - 1.5"	11	119	166	23	319
50 mm - 2"	1	65	201	48	315
75 mm - 3"	-	57	117	3	177
100 mm - 4"	-	-	16	2	18
150 mm - 6"	-	-	8	-	8
200 mm - 8"	-	-	3	-	3
Total	60,783	848	3,221	165	65,017

Wastewater Customers

Wastewater	Residential	Multi-Unit Residential	Commercial	Irrigation	Total
15 mm - 5/8"	57,933	22	1,197	8	59,160
18 mm - 3/4"	2,688	223	1,042	2	3,955
25 mm - 1"	141	362	399	11	913
40 mm - 1.5"	10	117	154	7	288
50 mm - 2"	1	65	160	8	234
75 mm - 3"	-	57	112	2	171
100 mm - 4"	-	-	11	-	11
150 mm - 6"	-	-	5	-	5
200 mm - 8"	-	-	2	-	2
Total	60,773	846	3,082	38	64,739

Drainage Customers

<u>Drainage</u>		<u>Residential</u>	<u>Multi-Unit Residential</u>	<u>Commercial</u>	<u>Total</u>
0 to 1,000 m ²	1	60,865	389	1,475	62,729
1,001 to 3,000 m ²	2	-	309	840	1,149
3,001 to 5,000 m ²	3	-	63	333	396
5,001 to 7,000 m ²	4	-	31	168	199
7,001 to 9,000 m ²	5	-	15	119	134
9,001 to 11,000 m ²	6	-	12	81	93
11,001 to 13,000 m ²	7	-	9	52	61
13,001 to 15,000 m ²	8	-	4	55	59
15,001 to 17,000 m ²	9	-	1	44	45
17,001 to 19,000 m ²	10	-	3	25	28
19,001 to 21,000 m ²	11	-	3	33	36
21,001 to 23,000 m ²	12	-	2	17	19
23,001 to 25,000 m ²	13	-	1	12	13
25,001 to 27,000 m ²	14	-	1	8	9
27,001 to 29,000 m ²	15	-	-	12	12
29,001 to 31,000 m ²	16	-	-	6	6
Over 31,000 m ²	17	-	1	109	110
Total Properties		<u>60,865</u>	<u>844</u>	<u>3,389</u>	<u>65,098</u>

Utility Rate History and Comparisons

The following tables detail the history of Utility rates since 2003, and the annual cost and annual cost increase for a sample residential customer with 360 cubic metres of water consumption a year.

Water Rate History

<u>Year</u>	<u>Fixed Annual Charge (\$)</u>	<u>Volume Charge (\$/Cubic Metre)</u>	<u>Cost for Sample Customer</u>	
			<u>Annual Charge for 360 Cubic Metres (\$)</u>	<u>Per Cent Increase (%)</u>
2003	109.50	0.79	393.90	3.1
2004	117.00	0.81	408.60	3.7
2005	123.00	0.83	421.80	3.2
2006	129.00	0.85	435.00	3.1
2007	135.05	0.88	451.85	3.9
2008	146.00	0.96	491.60	8.8
2009	160.60	1.05	538.60	9.6
2010	175.20	1.14	585.60	8.7
2011	189.80	1.24	636.20	8.6
2012	208.05	1.35	694.05	9.1
2013	226.30	1.47	755.50	8.9

Wastewater Rate History

Year	Fixed Annual Charge (\$)	Volume Charge (\$/Cubic Metre)	Cost for Sample Customer	
			Annual Charge for 360 Cubic Metres (\$)	Per Cent Increase (%)
2003	81.00	0.67	278.78	3.9
2004	87.00	0.69	290.69	4.3
2005	93.00	0.72	305.54	5.1
2006	99.00	0.75	320.40	4.9
2007	102.20	0.78	332.46	3.8
2008	116.80	0.85	364.07	9.5
2009	124.10	0.93	398.64	9.5
2010	135.05	1.01	433.20	8.7
2011	146.00	1.11	473.67	9.3
2012	160.60	1.21	517.79	9.3
2013	175.20	1.32	564.86	9.1

Drainage Infrastructure Levy Rate History

Year	Property Category	Annual Levy (\$)	Percentage Increase (%)
2003	1,000 square metres or less	60.00	22.0
2004	1,000 square metres or less	72.00	20.0
2005	1,000 square metres or less	78.00	8.3
2006	1,000 square metres or less	84.00	7.7
2007	1,000 square metres or less	91.25	8.6
2008	1,000 square metres or less	98.55	8.0
2009	1,000 square metres or less	105.85	7.4
2010	1,000 square metres or less	116.80	10.3
2011	1,000 square metres or less	127.75	9.4
2012	1,000 square metres or less	138.70	8.6
2013	1,000 square metres or less	149.65	7.9

Customer Impact of Utility Rates

Rates for water, wastewater and drainage for 2011 - 2013 were approved in conjunction with the 2011 Utility Budget. Examples of the impact of the 2013 rates are provided below.

Average Home Owner

The following chart illustrates the impact of the 2013 rates on a homeowner who uses 360 cubic metres of water per year. The water consumption is typical for a family of two adults and two children, in a home with two bathrooms, a dishwasher and washing machine, on a lot with typical landscaping for Regina. The cost increase resulting from the 2013 rates is about \$9.95 per month for the average homeowner.

2013 Rate Impact - Sample Home Owner

	2012 (\$)	2013 (\$)	Dollar Change (\$)	Per Cent Change (%)
Water				
Annual Basic Charge	208.05	226.30	18.25	
Annual Volume Charge	486.00	529.20	43.20	
Total Annual Water	694.05	755.50	61.45	8.85
Wastewater				
Annual Basic Charge	160.60	175.20	14.60	
Annual Volume Charge	357.19	389.66	32.47	
Total Annual Wastewater	517.79	564.86	47.07	9.09
Annual Drainage Infrastructure Levy	138.70	149.65	10.95	7.89
Total Annual Utility Charges	1,350.54	1,470.01	119.47	8.85

Sample Commercial Customer

The following chart illustrates the impact of the 2013 rates on a commercial customer with a 40 mm meter that uses 3,000 cubic metres of water per year, with a property size in the range of 3,001 to 5,000 square metres. This water consumption would be typical for a strip-mall with a restaurant and a hair salon with a parking lot and minimal landscaping.

2013 Rate Impact - Sample Commercial Owner

	2012 (\$)	2013 (\$)	Dollar Change (\$)	Per Cent Change (%)
Water				
Annual Basic Charge	375.95	408.80	32.85	
Annual Volume Charge	4,050.00	4,410.00	360.00	
Total Annual Water	4,425.95	4,818.80	392.85	8.88
Wastewater				
Annual Basic Charge	288.35	313.90	25.55	
Annual Volume Charge	3,557.40	3,880.80	323.40	
Total Annual Wastewater	3,845.75	4,194.70	348.95	9.07
Annual Drainage Infrastructure Levy	554.80	598.60	43.80	7.89
Total Annual Utility Charges	8,826.50	9,612.10	785.60	8.90

Rate Comparison - Sample Residential Customer

The following chart compares the 2012 rates for Regina and other cities for a sample residential customer. The sample customer is a home owner who uses 360 cubic metres of water per year. The water consumption is typical for a family of two adults and two children, in a home with two bathrooms, a dishwasher and washing machine, on a lot with typical landscaping for Regina.

Sample Residential Customer - 2012 Rates

<u>Utility Bill Details</u>	<u>Regina</u>	<u>Calgary</u>	<u>Edmonton</u>	<u>Saskatoon</u>	<u>Winnipeg</u>
Water					
Annual Basic Charge	\$ 208.05	\$ 163.68	\$ 78.60	\$ 137.76	\$ 76.65
Annual Volume Charge	486.00	535.54	628.14	338.91	486.00
Total Annual Water	<u>694.05</u>	<u>699.22</u>	<u>706.74</u>	<u>476.67</u>	<u>562.65</u>
Wastewater					
Annual Basic Charge	160.60	150.36	93.24	137.76	-
Annual Volume Charge	357.19	311.62	534.31	180.45	756.00
Total Annual Wastewater	<u>517.79</u>	<u>461.98</u>	<u>627.55</u>	<u>318.21</u>	<u>756.00</u>
Annual Drainage Infrastructure Levy	138.70	100.32	155.39	113.86	-
Total Annual Utility Charges	\$ <u>1,350.54</u>	\$ <u>1,261.51</u>	\$ <u>1,489.68</u>	\$ <u>908.74</u>	\$ <u>1,318.65</u>

Rate Comparison - Sample Commercial Customer

The following chart compares the 2012 rates for Regina and other cities for a sample commercial customer. The commercial customer has a 40 mm meter, uses 3,000 cubic metres of water per year, with a property size in the range of 3,001 to 5,000 square metres. This water consumption would be typical for a strip-mall with a restaurant and a hair salon with a parking lot and minimal landscaping.

Sample Commercial Customer - 2012 Rates

<u>Utility Bill Details</u>	<u>Regina</u>	<u>Calgary</u>	<u>Edmonton</u>	<u>Saskatoon</u>	<u>Winnipeg</u>
Water:					
Annual Basic Charge	\$ 375.95	\$ 441.72	\$ 267.12	\$ 1,455.84	\$ 105.85
Annual Volume Charge	4,050.00	3,354.60	3,577.62	2,266.14	3,763.20
Total Annual Water	<u>4,425.95</u>	<u>3,796.32</u>	<u>3,844.74</u>	<u>3,721.98</u>	<u>3,869.05</u>
Wastewater:					
Annual Basic Charge	288.35	150.36	93.24	1,455.84	-
Annual Volume Charge	3,557.40	2,460.00	4,452.60	1,861.44	6,300.00
Total Annual Wastewater	<u>3,845.75</u>	<u>2,610.36</u>	<u>4,545.84</u>	<u>3,317.28</u>	<u>6,300.00</u>
Drainage Infrastructure Levy	554.80	100.32	1,553.88	839.88	-
Total Annual Utility Charges	\$ <u>8,826.50</u>	\$ <u>6,507.00</u>	\$ <u>9,944.46</u>	\$ <u>7,879.14</u>	\$ <u>10,169.05</u>

Utility Operating Expenditures

Utility Operating Expenditures

Utility Operating Expenditure Summary (\$000's)

Expenditure Details (\$000's)	2012 Budget	2012 Actual	2013 Budget	Budget Change	
				Dollar Change (\$)	Percent Change (%)
Water, Wastewater & Drainage Operations and Construction					
Water Operations	10,902.0	12,215.1	12,016.7	1,114.7	10.2
Water & Sewer Construction	8,820.9	8,245.4	8,015.8	(805.1)	(9.1)
Sewer & Drainage Operations	4,686.1	4,314.3	5,223.5	537.4	11.5
Subtotal	24,409.0	24,774.8	25,256.0	847.0	3.5
Wastewater Treatment	6,228.4	6,300.0	7,869.6	1,641.2	26.4
Engineering & Operations					
Strategic and Business Services	1,439.8	1,427.5	1,559.4	119.6	8.3
Water, Wastewater Collection & Drainage Engineering	1,970.5	1,578.0	2,069.0	98.5	5.0
Environmental Engineering	1,110.9	902.4	1,429.5	318.6	28.7
Construction & Compliance Facilities	2,275.6	1,972.2	2,382.9	107.3	4.7
	238.6	254.5	238.6	-	-
Subtotal	7,035.4	6,134.6	7,679.4	644.0	9.2
Utility Administration					
Customer Service, Billing & Collection	3,782.4	3,667.6	3,971.7	189.3	5.0
Access Fee	6,881.2	6,881.2	7,380.9	499.7	7.3
Utility Administration Charge	4,350.4	4,350.2	4,708.3	357.9	8.2
Subtotal	15,014.0	14,899.0	16,060.9	1,046.9	7.0
Total Operating Expenditures	52,686.8	52,108.4	56,865.9	4,179.1	7.9
Other Expenditures					
Debt Costs	41,479.4	7,888.7	4,181.1	(37,298.3)	(89.9)
Total Expenditures	94,166.2	59,997.1	61,047.0	(33,119.2)	(35.2)
Net Utility Reserve Transfer	33,590.7	37,890.4	41,842.8	8,252.1	24.6

Staffing Summary

FTE's by Division ⁽¹⁾	2012			2013			Change
	Permanent	Casual	Total	Permanent	Casual	Total	
City Operations	193.4	26.7	220.1	205.7	27.4	233.1	13.0
Community Planning & Development ⁽²⁾	18.8	1.6	20.4	18.8	1.6	20.4	-
Corporate Services	25.5	1.5	27.0	25.5	1.8	27.3	0.3
Office of the City Manager	1.0	-	1.0	1.0	-	1.0	-
Total ⁽³⁾⁽⁴⁾	238.7	29.8	268.5	251.0	30.8	281.8	13.3

Note:

- The 2012 staffing summary has been restated to correctly reflect realignment of divisions.
- The 2012 Community Planning and Development permanent staff allocation has been restated to correctly reflect staff allocated to the Utility.
- Adjustments to allocations between the General Operating and General Utility funds has resulted in an increase of 4 permanent FTE in Utility Operating and corresponding reduction in General Operating in City Operations.
- In addition to staff increases noted in the Operating Analysis of Change, the City Operations complement has increased 3 permanent FTE in staffing funded through capital infrastructure renewal programs.

Operating Expenditure Summary (\$000's) by Type of Expenditure

Expenditures	2012 Budget	2012 Actual	2013 Budget	Budget Change	
				Dollar Change (\$)	Percent Change (%)
Salaries & Benefits	16,372.5	15,655.7	16,866.1	493.6	3.0
Employee Related Payments	83.4	89.2	83.4	-	-
Office & Administrative Expenses	821.3	864.8	866.0	44.7	5.4
Professional & External Services	2,613.4	1,253.0	3,126.6	513.2	19.6
Materials, Goods & Supplies ¹	4,636.0	4,802.8	5,305.4	669.4	14.4
Utilities and Other Expenditures	9,735.9	10,669.4	10,770.6	1,034.7	10.6
Intra-Municipal Services	18,424.3	18,773.5	19,847.8	1,423.5	7.7
Total Operating Expenditures	52,686.8	52,108.4	56,865.9	4,179.1	7.9
Debt Servicing	7,888.7	7,888.7	4,181.1	(3,707.6)	(47.0)
Total Expenditures	60,575.5	59,997.1	61,047.0	471.5	0.8
Net Utility Reserve Transfer	33,590.7	37,890.4	41,842.8	8,252.1	24.6

2013 Operating Expenditures

(thousands of dollars)

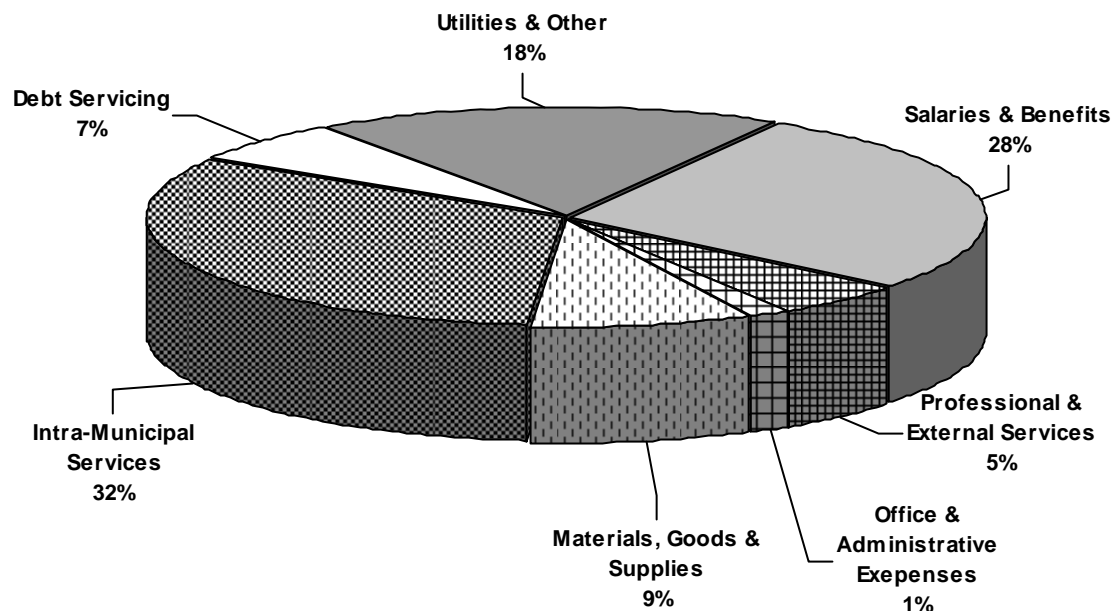

Analysis of Operating Budget Change from 2012 to 2013

Details of Operating Budget Changes *(continued on next page)*

(\$000's)

2013 Operating Expenditures		\$ 60,575.5
1.	Salaries and Benefits - Includes cost changes resulting from in-range progression increases, classification reviews, general employer benefit costs (EI, CPP, WCB, etc. which increase proportionate with salaries), the City's portion of increases in employee pension contributions and negotiated salary increase. (Base)	462.7
2.	2012 One Time Items - This represents one time items contained in the 2012 budget and includes Anaerobic Digester Cleaning at the WWTP, Succession Planning, Lift Station Preventative Maintenance System, Rear Lot Drainage Study and Improved Water and Sewer Utility Management Performance project. (One-Time)	(670.0)
3.	Power and Energy Costs - Increased power costs of 4.9% for various operations including Wastewater Treatment Plant, Water Pumping, Wells, and Forcemain Operations (Base)	161.7
4.	Liquid Alum and Polymer - Increased cost of material requirements for the Wastewater Treatment Plant, including liquid alum (aluminium sulphate), and polymer, which are utilized on a continuous basis in the treatment of wastewater. (Base)	36.5
5.	Purchase of Water - Increase in cost of water from Buffalo Pound Water Treatment Plant. (Base)	316.0
6.	Equipment Rental - Increased cost for tandem truck rental contract of \$30 per hour (55% increase) (Base)	330.6
7.	Pay Incentive for Certified Operators - Increased cost to provide a pay incentive for employees to obtain certified operator status. (Base)	20.0
8.	Allocation Adjustments from Operating to Capital - Adjustment of the operating budget to reflect costs moved to capital budgets for replacement of valve, hydrants, and sewer connections. (Base)	(1,139.3)
9.	Allocation Adjustments from General Operating to Utility Operating - Adjustment of the operating budgets to reflect the distribution of work. (Base)	656.0
10.	Utility Billing Staffing Level Change (Strategic Focus Cost Reduction) - Reduction in staffing costs through adjustment of staffing requirements. (Base)	(5.0)
11.	Vibratory Wheel Compactor (Strategic Focus Cost Reduction) - Reduction of materials costs through implementation of an improved work process in wastewater service connection replacement. (Base)	(54.0)
12.	City Hall Security Project - As part of the approved City Hall Security Strategy, Service Regina will provide two staff to provide first point of contact for any visitors to City Hall. This request represents 40% of the cost of these positions to be funded by the Utility. (0.8 Permanent FTE) (On-going)	48.0
13.	Water Connection Services - Increased staffing requirement to address volume of service requests to turn on water for new customers primarily due to growth. (0.25 Casual FTE) (On-going)	12.4
14.	Storm Sewer Cleaning & Storm Channel Maintenance - City growth has resulted in additional underground linear and storm channel infrastructure for stormwater conveyance of approximately 8% over the last 5 years. Increased resourcing is required to provide routine inspection and maintenance of this infrastructure. (1.0 Permanent FTE) (On-going)	126.9
15.	Domestic Sewer Cleaning - City growth has resulted in additional underground linear infrastructure for collection of domestic sewage of approximately 8% over the last 5 years. Increased resourcing is required to provide routine maintenance and inspection of this infrastructure. (0.5 Permanent FTE) (On-going)	121.4
16.	Summer Meter Service - City growth has resulted in increased requests from customers for the installation and removal of summer service water meters. This work is 60% funded through capital. (0.5 Permanent FTE) (On-going)	10.0

Details of Operating Budget Changes <i>(continued from previous page)</i>	(\$000's)
17. Linear Water Distribution System - City growth has resulted in additional underground linear infrastructure, valves and hydrants for water distribution of approximately 8% over the last 5 years. Increased resourcing is required to provide routine maintenance and inspection of this infrastructure. (2.0 Permanent FTE) (On-going)	140.0
18. New Water Pumping Station - City growth has required the construction of a new water pumping station as well as providing increased water pressure to north portions of the City. Increased funding and resourcing is required for the routine inspection, maintenance, and operation of this pumphouse. (0.5 Permanent FTE) (On-going)	216.0
19. New Bulk Water Loading Station - A new bulk water station has been constructed to provide for additional capacity for growth, security and safety. Incremental maintenance and operational costs will occur for electricity, natural gas, and routine facility maintenance. (On-going)	25.0
20. Upgraded McCarthy Sewage Pumpstation - Upgrades to McCarthy Sewage Pump Station to provide additional capacity for growth will result in increased costs for power/heat, and landfill tipping fees. (On-going)	28.0
21. Hydrant Access Procedures and Fees - New processes to ensure the protection of the water supply system will limit hydrant access to specific sites, increasing the time and cost to access water for daily operations of the Sewer and Drainage Operations Branch. This incremental cost will be partially offset through a one time request for an additional fill site in Building F North Garage (0.2 Casual FTE) (On-going)	40.0
22. Utility Billing Postage - Increased number of accounts has resulted in increased mailing costs. (On-going)	19.9
23. Office Space to Support Increased Capital Program - Additional office space is required to accommodate the additional staffing required to deliver the increased capital program. New facilities to support the needs of Utility operations is not expected to be constructed for 5-10 years. This funding is required to provide for the rental of office space. (On-going)	200.0
24. Lift Station Maintenance Program Staffing - Increased complexity of inspections and repairs to lift stations requires the conversion of existing general repair person to a Journey person Industrial Mechanic. (On-going)	30.0
25. Jet Nozzle Replacement - Regular replacement of jet nozzles improves the productivity and effectiveness of underground pipe cleaning programs. An one-time and ongoing replacement program will enable the replacement of 6 nozzles in 2013 and a program to replace 2 nozzles annually. (On-going/One-time)	30.0
26. Anaerobic Digester Cleaning - This funding is required to complete cleaning of anaerobic digesters at the Wastewater Treatment plant to maintain them in good working order (On-going)	160.0
27. UV Disinfection Maintenance - In order to ensure that the Wastewater Treatment plant continues to meet Permit during the upgrade and refurbishment of the existing plant, the ultraviolet disinfection system will need to be run with all systems operational. This will necessitate increased spending on parts and lamps. (On-going)	40.0
28. Increased Wastewater Treatment Demands - As the existing Wastewater Treatment Plant nears the end of its capacity and useful life, there are increased maintenance and operating activities and costs to ensure the plant continues to meet the daily demands of the community and growth, while remaining in compliance with the City's Operating Permit. On-going increases for polymer, alum, and electricity (618.0) will continue each year until the new plant is operational. A one-time request of 935.0 for increased chemical costs and contracted services is required to address short term issues to be addressed through interim capital improvements. (On-going/One-time)	1,553.0
29. Proactive Storm Cleaning Plans - As the underground pipe system has aged and resources have been allocated at times to address other higher priority work, a backlog of cleaning needs has developed. This one time request will provide for the development of a plan to assess the existing backlog and provide recommendations. (One-time)	50.0

Details of Operating Budget Changes <i>(continued from previous page)</i>	(\$000's)
30. Water Meter Accuracy Testing - This one-time request will provide resourcing for a one-year trial of proactive testing of large water meters in order to provide improved metering accuracy and increased revenues. The one-year trial will provide an assessment of the value/cost-savings of continuing with this type of program on an ongoing basis. (One-time)	22.0
31. Sewer Display Model - Repair of the Sewer Display Model to support homeowner education and promote use of effective residential drainage and sewer backup prevention strategies. (One-time)	10.0
32. Utility Budget and Business Improvement Strategy Support - Support for development and continued improvement of the annual Utility budget. The budget analysis and results will also provide input to the Utility Business Improvement Strategy (UBIS) project, including development and full implementation of improved budgeting criteria and processes and delivery of a performance based rate review for 2014-2017. (One-time)	90.0
33. Communities of Tomorrow Innovation Funding - The Leveraged Municipal Innovation Fund within Communities of Tomorrow provides a platform for municipalities to pool their efforts and resources to seek innovative solutions to address current and emerging infrastructure needs. This one-time request will cover the Utility's share of the City's contribution for 2013. (One-time)	27.0
34. Core Park Underground Detention Cleaning - To re-establish storm water detention design capacity this project involves the removal of sediment that has accumulated and that is reducing capacity of this on-line underground storm water detention reservoir. (One-time)	100.0
35. Capital Engineers - In order to support the on-going capital infrastructure renewal work, additional engineering resources are required. This request will provide for three additional engineers to support the capital program. The funding fro these positions is provided for in the existing capital program. The work plan for the capital program anticipates the use of consulting resources to provide additional support. If consulting resources are not available, a further two capital engineer positions will be required, bringing the total required staffing addition to five. (3.0 to 5.0 Permanent FTE) (On-going request funded through Capital Program)	-
36. Drafting Coordinator - The addition of a coordinator to oversee the work of the Drafting and Infrastructure Records area will provide resources to manage the increased workload associated with increased development. (1.0 Permanent FTE) (On-going request funded through Servicing Agreement Fees)	-
35. Administrative Charge - Increase in the administrative charge as per the policy. The charge is 5% of the prior year's budgeted revenue. (Base)	358.0
36. Debt Costs - This represents the change in total interest and principle payments for the Utility in 2013. (Base)	(3,707.6)
37. Access Fee - Increase in Transfer to General Operating Fund in Lieu of Taxes. (Base)	499.7
38. Other miscellaneous costs include adjustment of allocated costs including increased landfill disposal costs, purchase of gravel & sand for backfill, and increased postage rates. (Base)	106.6
2013 Operating Budget	\$ 61,047.0

Note:

1. *Base request funding – represents an increase in cost necessary to maintain current investment levels.*
2. *On-going request funding – represents expenditures that would be ongoing past the current budget year.*
3. *One-Time request funding – represents one-time expenditures for the current budget year.*

Water and Sewer Utility Description

Mandate

We will be recognized by our customers and beneficiaries for excellence in sustainable stewardship of our water resources and utility assets protecting public health, safety, property and the environment.

We strive to maintain current service levels by managing Utility services based on 3-5 year needs assessments with reasonable rate increases.

A brief overview of the purposes of each work area is outlined below.

Environmental Engineering Branch (City Operations Division)

Provides environmental engineering services for Regina to protect public health and enhance the quality of life.

Water and Sewer Services Department (City Operations Division)

Provide design, construct, operate and maintain essential water, wastewater and drainage systems for Regina and surrounding communities to protect public health and property. This department includes the following branches funded through the Utility:

- Water Operations Branch
- Water and Sewer Construction Branch
- Sewer and Drainage Operations Branch
- Water, Wastewater, and Drainage Engineering Branch
- Wastewater Treatment Branch

Strategic and Business Services Department (City Operations Division)

Provide strategic, engineering and business leadership for City Operations by delivering results through aligned planning; coordinated administration & communications; research & policy development and; performance & measurement reporting. This department also provides customer service for Utility customers through the Service Regina branch. The Utility budget for this department includes:

- 40% of the overall cost of the department

Due to reorganization in the City Operations Division, the allocation for the Strategic and Business Services Department will be reviewed in 2013.

Construction and Compliance Department (formerly the Development Engineering Department, Community Planning and Development Division)

This department formerly provided the planning, design, and review services that support the new the City needs to grow and thrive. It also provides drafting, infrastructure records, infrastructure coordination, and geomatics services to the corporation. The Utility budget for this department has previously included:

- Infrastructure Development Branch – Water/Wastewater and Drainage work units
- 40% of the remainder of the department, excluding Infrastructure Development Branch Roadways work unit

In 2012, this department was dissolved with planning responsibility moving to the new Infrastructure Planning Branch in the Planning Department and design and construction moving to the new Construction and Compliance Department in its Engineering Services Branch. As a result of these changes and an increasing workload associated with the utility component of growth, the allocation for these costs will be reviewed in 2013.

Finance Department (Corporate Services Division)

Provide accurate and timely billing and collection information to ensure the financial health of the Utility and to accomplish our commitments to customer satisfaction and business excellence. The budget for this department includes:

- Utility Billing Branch
- Direct charges for one FTE of Financial Analyst resources

Information Technology Department (Corporate Services Division)

Provide collaborative leadership and support in technology, information and services; enabling our customers to meet their business outcomes. The budget for this department includes:

- Application development staffing directly responsible for the Utility Billing system as well as 0.5 FTE of database administration resources.

Communications (Office of the City Manager)

For the Water & Sewer Utility, the Communications Branch provides public communications for the Utility. The Utility Budget includes:

- Direct charges for communications for the utility, along with one FTE of staff resources

Buffalo Pound Water Administration Board

The Board was formed as a partnership between the Cities of Moose Jaw and Regina and sells wholesale water to both Cities.

Water

Water System Overview

The water supply, pumping and distribution system provides water for residential and commercial use and fire protection. The system serves a population of approximately 200,000 including all residents and businesses in the city limits and a number of customers outside the city. Service goals include:

- Providing water that meets or exceeds Provincial water quality standards and objectives.
- Providing water at adequate pressure and in sufficient quantity to satisfy the requirements for domestic and commercial use, irrigation and fire protection.
- Identifying and implementing improvements to the water system through long range planning, monitoring, improved operation, capital works and new technology.
- Participating in Communities of Tomorrow and National Research Council's Centre for Sustainable Infrastructure Research to develop new technologies and improve practices.

Components of the water system shown in the map on the next page include:

- **Buffalo Pound Lake and Wells** – All of the annual water needs are provided from Buffalo Pound Lake. There are wells available for backup purposes. The well water is chlorinated, but does not require further treatment to meet current health standards.
- **Buffalo Pound Water Treatment Plant** – Water from Buffalo Pound Lake is drawn and pumped three kilometres to the Buffalo Pound Water Treatment Plant, a facility owned jointly with the City of Moose Jaw. At the plant, the water is mixed with coagulants that cause algae, bacteria and other impurities to clump together so that they settle out of the water. The water is then filtered and chlorinated. During warmer weather, the water is passed through granular activated carbon to improve the taste and odour.
- **Supply Pipelines** – From the Buffalo Pound Water Treatment Plant, the water is pumped through a 56 km pipeline to the City's water distribution system. The pipeline has been twinned to provide increased capacity and reliability of the water supply. A number of other supply pipelines transport water from wells to reservoirs.
- **Reservoirs** – Five storage reservoirs are used to store water to meet peak demands and ensure that there is an adequate supply of water available for firefighting and high usage periods. The reservoirs have a combined usable storage capacity equal to about one and one-half days of average water use.
- **Pumping Stations** – There are three pumping stations (North, Farrell and Ross) that are used to pump water from reservoirs into the distribution system as necessary.
- **Distribution System** – The distribution system consists of over 1,080 kilometres of pipelines ranging in size from large 1,067 mm diameter trunk mains to 100 mm distribution pipes. The pipelines are made of various materials including steel, cast iron, concrete, asbestos cement (AC), polyvinylchloride (PVC) and high density polyethylene (HDPE). The distribution system also includes over 6,000 valves that allow the water to be turned off to facilitate repairs and maintenance.
- **Service Connections** – Distribution pipes are connected to a customer's water line through a service connection.
- **Water Meters** – Water meters measure water consumption which use automated meter reading (AMR) equipment to transmit meter readings to a mobile data collection unit.

WATER SYSTEM

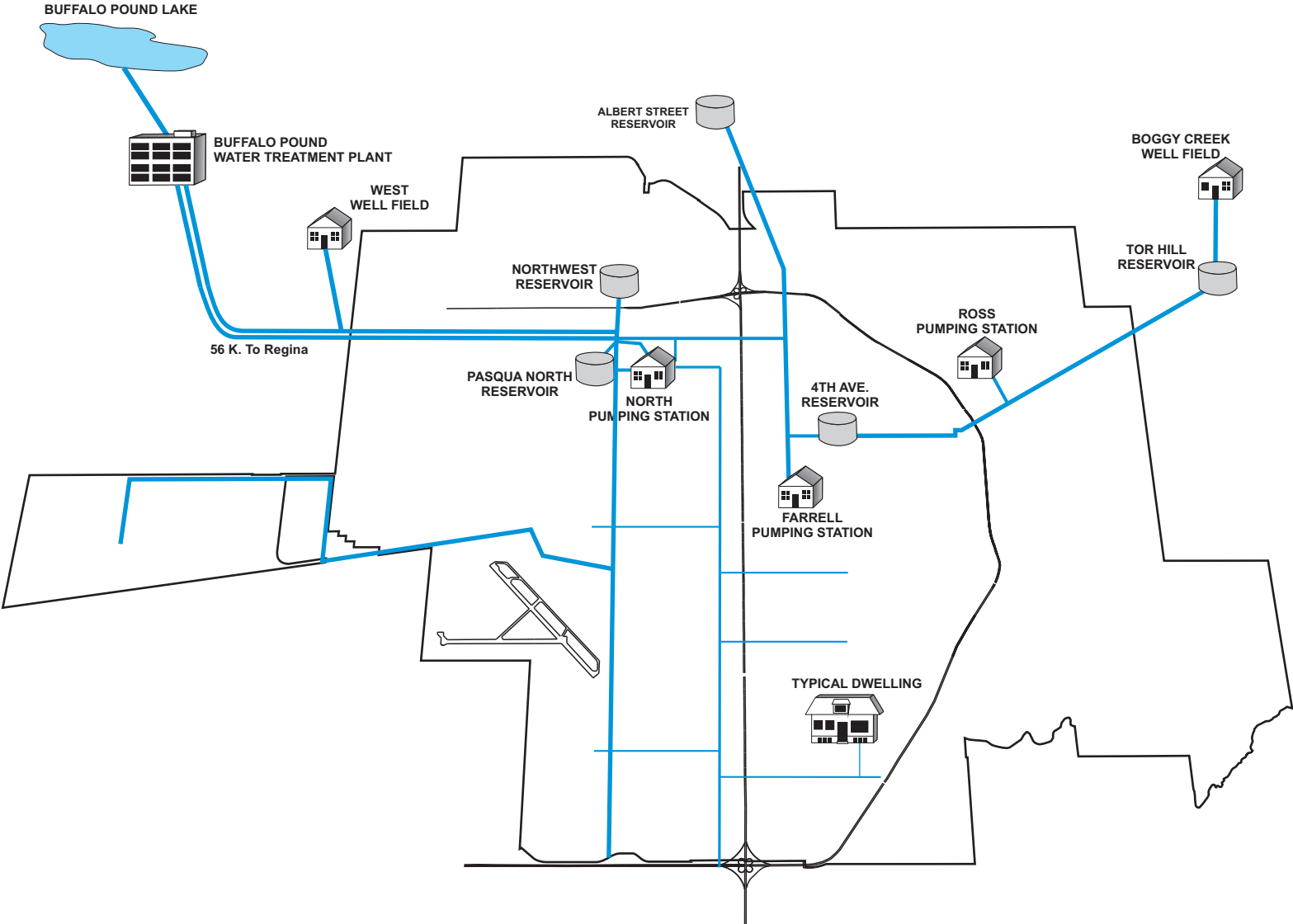

SERVICE CONNECTION

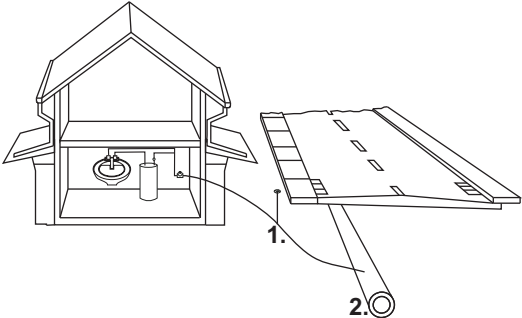

- 1. Service Connection (Curb Box)
- 2. Watermain

— Supply System
— Distribution System

Water System Objectives

The Long Term Water Utility Study, initially completed in 1993, covered all aspects of the water system, including projected future water requirements, the condition of the existing system components, and a review of the system operations. The Study was adopted by City Council as the city's long term water supply plan. In 1998, a portion of the Study was updated and resulted in a decision to improve the Buffalo Pound supply pipeline and pumping system rather than construct a ground water treatment plant. A Study update was completed in 2006 and provided recommendations for water system improvements for the next 20 years.

As part of the Study, a number of objectives were established. These objectives continue to guide the water system operations today, and include:

- **Water Quality** – The City adopted the *Guidelines for Canadian Drinking Water Quality, 4th Edition* published by Health Canada as the basis for its water quality objectives. These are the most complete guidelines established in Canada. The standards, adopted by Saskatchewan Environment, regulate the operation of all waterworks in Saskatchewan.

For parameters not included in the *Guidelines*, the City has reviewed standards listed by other authorities and adopted appropriate criteria. Some parameters are for substances for which there are aesthetic concerns rather than health concerns, such as iron, manganese and hardness. Other parameters are for substances to which health concerns have been linked but not proven, such as aluminum and trihalomethanes.

- **Water Conservation** – An enhanced Water Conservation Program was initiated in 1991 to reduce the per capita water consumption and the short term peak water demand. The City to date has been successful in meeting the targets that were set for the program.
- **Reliability** – The City established an objective for the reliability of delivery, defined as ensuring water will be available within the limits of minimal local disruptions for system maintenance and rare large-scale disruptions due to unforeseen catastrophe. Specific objectives are:
 - Mandatory water rationing should occur less than one year in ten.
 - Service should be restored within 24 hours in the event of local service disruptions such as water main breaks and connection problems.
 - All reasonable steps should be taken to ensure that large-scale disruptions do not occur. These steps include ensuring that there is sufficient redundancy in the system so that alternate facilities can be used in the event of a failure in part of the system.
 - Alternate power sources should be available in the event of a main power failure.
 - Hydrants should be installed and maintained to meet the requirements of the National Fire Code.
- **Water Pressure** – Water must be delivered to customers under pressure. It is desirable to maintain pressure standards between a minimum and maximum range. The pressure under which water is delivered to a customer depends upon many factors, including the consumption by other customers, pumping capabilities, pipe size, velocity of the water through the system, and the design of the water system.

Water pressure can be controlled to a certain extent through the operation of pumps and other components of the system. However in some instances, system changes may be necessary to meet pressure standards.

As part of the Long Term Water Utility Study, desirable ranges for pressure and velocity were identified and system improvements were recommended where conditions fell outside of these ranges. Work is currently underway to design and construct a second pressure zone to address lower pressures in the north end of the city.

- **Efficiency of Operations** – Electricity used in pumping water is a significant cost. This cost is a factor of the efficiency of the pumps as well as the hydraulics of the system. Pumping operations are regularly reviewed to identify where system improvements or operational changes could reduce electrical costs. Changes are pursued when cost-effective.

Water Supply

Buffalo Pound Lake now provides 100% of Regina's water needs. The water is treated at the Buffalo Pound Water Treatment Plant, which is jointly owned by the cities of Regina and Moose Jaw. It was built in the 1950s in order to provide water for those two cities. The facilities are administered by the Buffalo Pound Water Administration Board, which consists of two members appointed by the City of Regina and one member appointed by the City of Moose Jaw.

Although the plant is operated as a separate entity, there is a high degree of communication and cooperation between the plant operators and the two cities.

On an annual basis, the Board establishes a general water rate. The rate is established on a cost-recovery basis. The 2013 rate will be \$225.02 for one million litres, a 3.9% increase over the 2012 rate. The increase is expected primarily due to rising costs for electricity, increases in unit prices for treatment chemicals, equipment price increases, and increases for wages and benefits.

Since Buffalo Pound Lake is shallow and prone to the growth of algae and other organic materials, treatment of the lake water is challenging. Over the last ten years, the lake water has required higher levels of treatment to provide water that meets the City's water quality objectives.

The City's budgeted 2013 cost of water purchased from Buffalo Pound is approximately \$6.4 million, or about 53.5% of the total costs of the Water Supply, Pumping and Distribution Program, or about 13.0% of total Utility costs excluding debt and transfer to the General Operating Fund.

Future planning for the plant must address new and anticipated regulations related to health effects. The review and update of the City's Long Term Water Utility Plan includes a study of the Buffalo Pound Water Treatment Plant. Results of the study include:

- **Disinfection** – The plant uses chlorine for treatment and disinfection. Chlorinating naturally occurring organic material results in the formation of disinfection by-products known as trihalomethanes and haloacetic acids, which are harmful to human health. The Study recommends reducing the use of chlorine if possible in conjunction with the addition of ultraviolet light disinfection which is effective in reducing risks associated with cryptosporidium.
- **Taste and Odour Control** – The plant uses granular activated carbon and powdered activated carbon to control taste and odour generated by algae in Buffalo Pound Lake. The percentage of time that taste and odour control is required has been increasing for a number of years. The Study discusses the performance of a detailed analysis of additional contactors versus additional storage for granular activated carbon but recommended a third screw pump and four additional contactors.
- **Treatment Residuals Management** – The treatment processes remove particulate matter along with approximately 6% of the total water volume from the lake water. This residual must then be treated and disposed to the environment. The existing wastewater lagoons are overloaded and under review.

- Water Stability – Treated water is slightly corrosive which leads to the softening of concrete tanks in the water treatment plant and the slow deterioration of piping and fittings in the water distribution system which contains metal. Corrosion control in the form of protective coatings for concrete tanks and pH adjustment of treated water is recommended in the Study. Subsequent study indicated that concrete deterioration is not a cause for immediate concern and is not a current priority.

An engineering consultant has been engaged to initiate a review of upgrade concepts identified in the 2006 update to the Long Term Planning Study, and to move forward on predesign and detailed design of confirmed upgrades over multiple year capital program.

A Waterworks System Assessment (WSA) was completed for the Buffalo Pound Water Treatment Plant in 2010. WSA's are required every five years in accordance with Saskatchewan Environment's 2002 Water Regulations. The WSA evaluates current performance, level of optimization, functionality, capability, efficiency and sustainability of the waterworks and identifies required improvements. Recommendations from the 2010 WSA are currently under review.

As part of the total water purchase costs the two cities also contribute an amount equal to 10% of the general water charges to a Capital Replacement Reserve used to pay for replacement and upgrading of equipment in the plant. Costs for major improvements to the plant are shared with the City of Moose Jaw. The cost-sharing ratio is determined by the percentage ownership of each City, which at the present time is approximately 73% for Regina and 27% for Moose Jaw.

Regina can also draw water from 9 wells located in and around the City. Wells currently are available for emergency water supply in the event of a failure in the Buffalo Pound Water Supply; however, the amount available from the wells is less than the City's typical daily needs. The well water meets current regulatory standards but has levels of iron, manganese and hardness that do not meet aesthetic objectives. These minerals can cause staining on fixtures, as well as the appearance of "discoloured" water. The minerals also cause problems by forming deposits in the water system, requiring more frequent maintenance.

A number of tests are carried out to ensure that water meets quality objectives. Tests include:

- Water quality at the Buffalo Pound Water Treatment Plant is extensively monitored. On-line analyzers are used to monitor the major parameters. The water is continually monitored after every treatment stage. Laboratory staff perform over 25,000 analyses per year monitoring 65 different water quality parameters. The cost of these procedures is included in the general water rate for water purchased from Buffalo Pound.
- Tests are also carried out at various points in the City's water supply and distribution system. Regular sampling and testing is done in order to comply with provincial requirements for the operation of the water system, as well as to ensure the City's water quality objectives are met.

Test results show that the water supply meets all regulatory guidelines.

In addition to carrying out testing of treated water, steps are taken to safeguard the water supply. Identification and prevention of possible sources of groundwater contamination is an ongoing process. Saskatchewan Watershed Authority in conjunction with stakeholders completed a Source Water Protection Plan for the Upper Qu'Appelle and Wascana Creek watersheds in 2008.

Water Pumping

Three pumping stations are used to pump water from reservoirs into the distribution system. The operation of all stations must be coordinated along with supplies from Buffalo Pound and other components of the supply system such as the reservoirs. Since electrical costs are a major component of this operation, it is important that the pumps are operated in an efficient manner. Water pumping must also be provided when electrical power failures occur.

In order to coordinate the operation of each station and to operate the pumps in an efficient and reliable manner, system data is recorded and monitored. This information is obtained from a computerized Supervisory Control and Data Acquisition (SCADA) system.

Water Distribution

The water distribution system consists of buried pipelines made of cast iron, asbestos cement (AC), polyvinylchloride (PVC) and high density polyethylene (HDPE). Steel is used for large supply mains exceeding 500 mm in diameter. Cast iron pipe was installed from 1904 until the 1940s. AC was used throughout the 1950s, '60s and '70s. AC and PVC pipe comprise approximately 55% and 30% respectively of the 1,080 kilometre of mains in the system. Approximately 107 kilometres of cast iron pipe has been replaced with PVC pipe since 1980. Some cast iron pipe remains due to location and size considerations (intersections, 400 mm diameter and over) and will be replaced as the need and opportunity arises. The replacement of cast iron pipe with PVC pipe has allowed for significant savings in maintenance repairs.

Watermain breaks are a primary cause of water service disruptions, water losses and discoloured water. The frequency of breaks is influenced by the pipe materials, age and location. The cast iron and asbestos cement pipes have a failure rate of approximately 0.3 breaks per kilometre.

Water Quality Monitoring

Water quality monitoring activities include:

- Administering the Permit to Operate Water Works for operation of the water system, including water quality monitoring of all water sources and the distribution system, maintaining records related to the safety and operation of the water system and ongoing reporting to the Ministry of Environment.
- Carrying out supplemental testing to gather water quality data from the water distribution system.
- Communicating information about water quality to the public.
- Efforts to protect the City's water source at Buffalo Pound Lake and the Regina area aquifers.
- Upgrades to the City's water quality data collection and management system through the use of "WaterTrax", an internet-based database service. WaterTrax provides water quality test results directly from testing labs, as well as notifications and alarms to users. Reports can be generated as required by regulators.

Water Loss Reduction

All water utilities experience a certain amount of water loss through leakage, breaks, unauthorised consumption, meter inaccuracies or data handling error. In 2006, the City of Regina changed the method for reporting water loss. The International Water Association (IWA) Water Loss Task Force has produced an international best practice standard approach for water balance calculations and the estimation of water loss. This best practice has also been adopted by the American Water Works Association (AWWA) and by the Federation of Canadian Municipalities (FCM) InfraGuide Best Practice “Water Use and Loss in Water Distribution Systems”.

The international best practice performance measure advocated by the IWA and AWWA is the Infrastructure Leakage Index (ILI). The ILI is defined as the ratio of Current Annual Real Losses (Real Losses defined as physical water losses from the pressurized system up to the point of customer consumption) to the Unavoidable Annual Real Losses (UARL defined as a theoretical reference value representing the technical low limit of leakage that could be achieved if all of today’s best technology could be successfully applied). The ILI is a highly effective performance measure because it is:

- Based on a calculation that has been tested globally;
- Unit-less and based on real water loss;
- System specific taking into account operating pressure, service connection length, pipe condition and water meter location; and
- Comparable to an international data set.

To date, 27 municipalities in Canada that are participating in water system benchmarking have or are undertaking this method of determining an (ILI) index for their water distribution systems.

The 2011 calculated ILI of 3.63 for the City of Regina is within the “Good” Technical Performance Range of 2.0 to 4.0, but there is potential for marked improvements. For comparison purposes an ILI index of 1.0 to 2.0 is within the “Excellent” Technical Performance Range and indicates that further water loss reduction, although possible, may be uneconomical.

The following table identifies the water loss between 2007 and 2011:

Water Volumes (million cubic metres)	2007	2008	2009	2010	2011
Total Water Supplied	28.5	28.0	27.6	26.0	27.4
Billed Consumption	23.7	23.2	22.6	21.1	22.1
Unaccounted Water	4.8	4.8	5.0	4.9	5.0
Unaccounted Water as a Per Cent of Total Water Supplied (%)	16.84	17.14	18.12	18.85	18.25

Water Consumption and Conservation

The 2013 budget is based on an estimate of billable water consumption of almost 23.1 million cubic metres. About 58% of the consumption (13.5 million cubic metres) is for residential properties, 11% (2.5 million cubic metres) for multi-residential properties, and 31% (7.1 million cubic metres) is for non-residential properties.

The City has had a Water Conservation Program since 1985 and initiated an enhanced program in 1991. The primary goals of the program are to reduce the average per capita water consumption and the peak day water use.

The following table provides the history of metered water consumption.

Metered Water Consumption
(Million Cubic Metres)

<u>Year</u>	<u>Metered Water Consumption</u>
1995-1999	24.4*
2000-2004	23.8*
2005-2009	22.7*
2010	21.1
2011	22.1

* Five Year Average

The Water Conservation Program consists of identifying information that should be provided to the public on methods of conserving water, and communicating the information by means such as:

- Web page information.
- Xeriscape landscaping information available on the website.
- Matching grant program for schools.

Cross Connection Control and Backflow Prevention Program

Water quality can be compromised by the introduction of contaminants into the distribution system. This can occur wherever there is a cross connection, which is a link between the drinking water supply and a source of contamination such as a pesticide container on a garden hose or a boiler filled with anti-corrosion chemicals. Various conditions can cause backflow and/or backpressure in the water supply system. This can cause the drinking water to move in the opposite direction and take with it any materials it is in contact with or mixed with. The result is the water supply to a building or neighbourhood becomes polluted or contaminated.

The Cross Connection Control and Backflow Prevention Program was established in 1996 to reduce the possibility of contamination from such causes. Since the program was established, all new facilities have been reviewed for backflow prevention requirements through the building permit process. All existing commercial, institutional and industrial facilities are being inspected by the City. Any backflow requirements are identified and a one-year time frame given to become compliant.

The four primary components of the program are:

- Public education and awareness.
- Inspections of commercial, industrial and institutional facilities.
- Administration of the annual testing of testable backflow prevention assemblies.
- Review of appropriate building permits for new facilities.

Wastewater

Wastewater System Overview

The wastewater collection and treatment system collects sewage from residential, institutional, commercial and industrial customers in the city. Wastewater treatment and final effluent meet provincial environmental standards. Service goals include:

- Collecting domestic, commercial and industrial wastewater in the City and reliably delivering it to wastewater treatment facilities.
- Producing a treated wastewater effluent that is biologically and physically safe for the environment and which meets the requirements of the provincially issued operating permit.
- Ensuring solids removed from the wastewater are treated and disposed of in an environmentally responsible manner.

Components of the wastewater system shown in the map on the next page include:

- **Service Connections** – Building plumbing systems are attached to the wastewater collection system by a service connection pipe. The City owns and is responsible for the maintenance of the service connection pipe on the “City side” of the property line.
- **Collection Mains and Trunk Mains** – The service connection pipes are attached to wastewater collection mains which are typically 200-250 mm in diameter. The collection mains drain into trunk mains which are 300 mm or more in diameter. The system includes approximately 860 kilometres of pipeline.
- **Manholes** – Over 15,000 manholes provide access to the wastewater collection system for maintenance and repair.
- **Lift Stations** – Wastewater flows through the collection system by gravity. In low-lying areas in the city, lift stations must be used to pump the wastewater to collection and trunk mains at a higher elevation. Wastewater then continues to flow by gravity from that point eventually reaching the McCarthy Boulevard Pumping Station. There are 18 lift stations in the wastewater collection system.
- **McCarthy Boulevard Pumping Station** – All wastewater collected in the City flows to the McCarthy Boulevard Pumping Station. The station provides screening and continuous transfer of wastewater from the collection system to the wastewater treatment facilities five kilometres west. The McCarthy facility is capable of transferring wastewater at up to four times the average daily rate. The station is also the existing location where commercial septic tank haulers offload into the wastewater system.
- **Septage Receiving Station** – The Utility provides a service by receiving trucked liquid waste at a receiving station. The Septage receiving station is currently being reviewed for relocation from the McCarthy Boulevard Pumping Station.
- **Wastewater Treatment Plant** – The plant processes wastewater through four stages of treatment:
 - Primary treatment removes sand, grit and organic material from the sewage.
 - Secondary treatment reduces dissolved organic material through the use of aerated lagoons.
 - Tertiary treatment removes phosphorus, algae and suspended solids by using aluminum sulphate and polymer.
 - Ultraviolet light is used to disinfect the effluent before it is released into Wascana Creek.

WASTEWATER SYSTEM

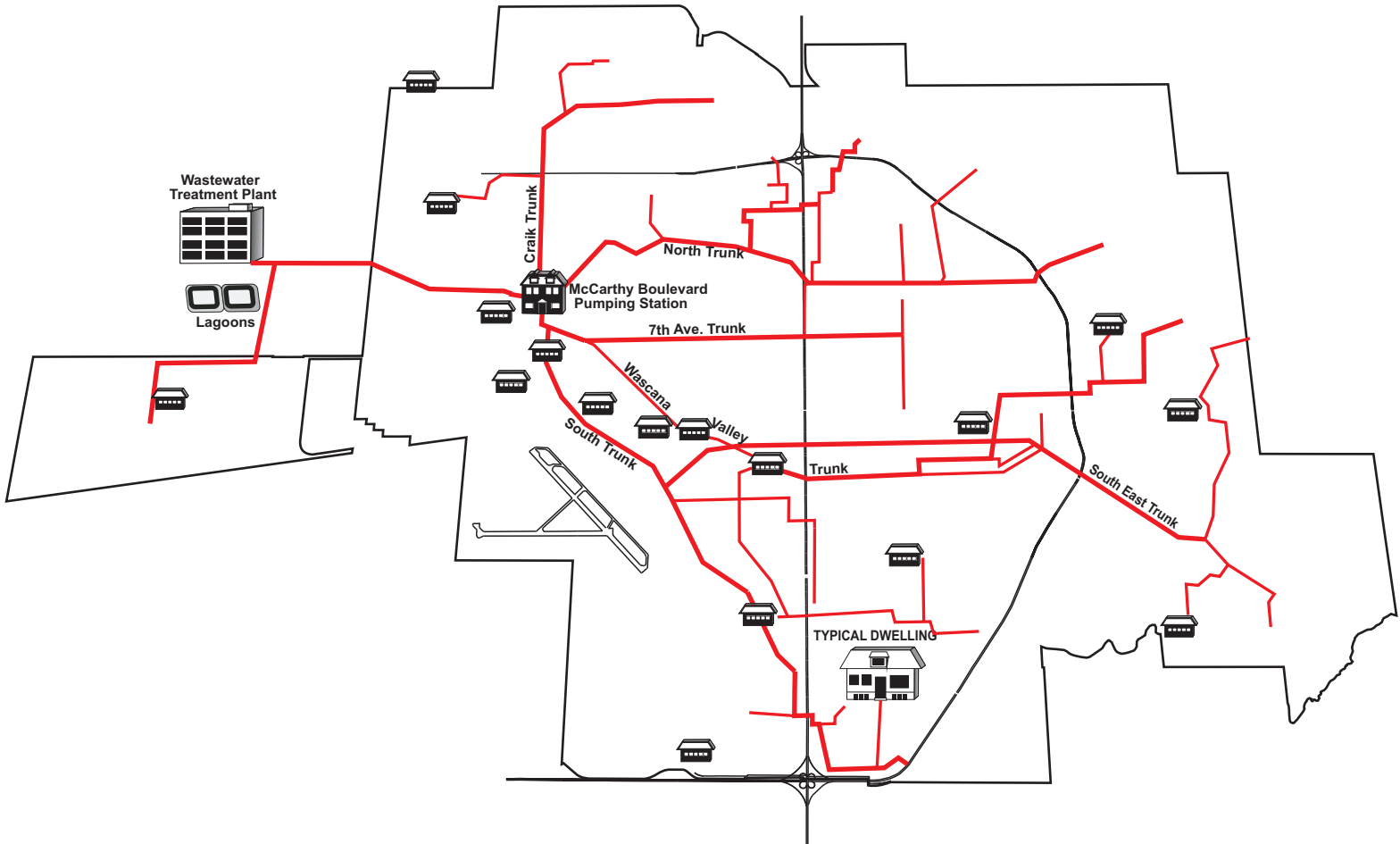

Service Connection

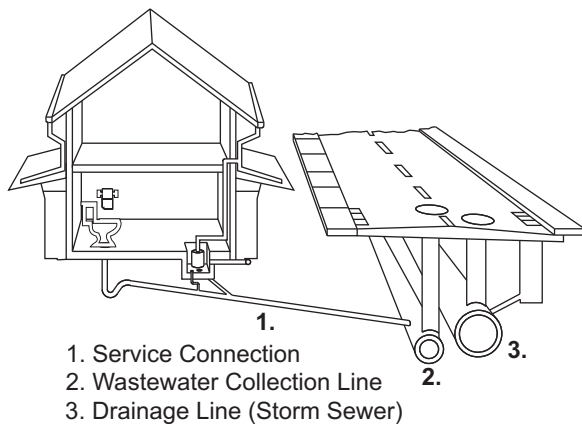

Wastewater System Objectives

The provision of wastewater collection and treatment services is critical to the health and environment of the citizens of Regina and surrounding area. Objectives for wastewater collection and treatment are:

- **Quality of Sewage Effluent** – Treated wastewater from the City's wastewater treatment plant is discharged into Wascana Creek, which flows into the Qu'Appelle River upstream from the town of Lumsden. Federal and Provincial agencies establish criteria for sewage effluent that each wastewater facility in the province must follow. The major criteria are total phosphorus, fecal coliform bacteria, pH, biological oxygen demand and suspended solids in the treated effluent discharged to Wascana Creek.
- **Reliability of the Collection System** – Improperly functioning wastewater collection systems cause inconvenience, health and safety concerns. Grease and solids build-up, deterioration of pipes, sags and breaks in wastewater collection lines and at connections caused by shifting soil, tree roots and foreign materials in the lines cause problems such as blockages and reduced capacity. To prevent these problems a regular inspection and maintenance program is required.
- **Relining/Rehab Program** – A successful relining and spot repair program has been ongoing in the City for many years at locations where work is identified in conjunction with roadways programs. This initiative has been expanded to address additional locations proactively before they deteriorate to the point that excavation and replacement is our only option. The use of this trenchless technology greatly reduces rehabilitation costs and disruption to the public and the customer.
- **Separation of the Drainage System from the Wastewater Collection System** – The wastewater collection and treatment system is adequate to handle the day-to-day wastewater flows from the city. During rainfall and snow melt events, drainage water enters the wastewater collection system through basement sump pits connected to weeping tile drainage, catch basins inadvertently connected to the wastewater collection system, and infiltration through pipe cracks and openings such as wastewater manhole covers. Reducing the amount of drainage water entering the wastewater collection system can postpone large expenditures required for trunk mains and treatment plant capacity expansions. Work is being done to reduce infiltration to both new and existing wastewater mains and trunks.
- **Odour Control** – One of the by-products of wastewater collection and treatment is odour. Such odours are unpleasant for nearby residents and staff. Reduction of odours is accomplished by the use of containment, chemicals and aeration lagoons. The aeration equipment at the treatment facilities injects oxygen into the wastewater, preventing a septic environment that produces strong odours.
- **Efficiency of Operations** – Electricity is primarily required to operate pumps and aeration blowers. Chemicals such as aluminum sulfate and polymer used to remove phosphorus are a significant cost of operating the wastewater treatment plant. To minimize costs, it is important to make effective use of chemicals required to meet effluent targets. The most efficient use of electricity, chemicals and other inputs is accomplished by automatic process control and laboratory based performance information at all stages of the treatment process.
- **Maintaining Treatment Capacity** – Regina uses five aeration lagoons in its secondary treatment process. Over the years, as solids settle to the bottom of the lagoons and aeration systems deteriorate, capacity is diminished. To maintain treatment capacity, old lagoons must be refurbished.

Drainage

Drainage System Overview

The drainage system collects water from rainfall and melting snow in and around the City and conveys it to Wascana and Pilot Butte Creeks. The system serves over 65,000 residential and commercial properties. Service goals include:

- Collecting and controlling drainage water within the city to minimize inconvenience, property damage and danger to the public.
- Monitoring the potential for flood conditions in Wascana Creek and the drainage channels and carrying out flood control measures as required.

The **Minor Drainage System** consists of the underground piping system that collects and transports small to medium amounts of drainage from rainfall, snow melt and minor storms. Components of the minor system include:

- Catch Basins – Over 25,000 catch basins located in streets and open space areas collect water and direct it into the drainage lines. Catch basins are designed to keep sand, silt and other matter out of the piping system by causing it to settle to the bottom of the catch basin.
- Lines, Mains and Trunks – There are approximately 700 kilometres of drainage lines located beneath streets. Lines and mains range from 200 mm to 1200 mm in diameter, with trunks over 1200 mm.
- Manholes – Over 15,000 manholes provide access to the system for maintenance and repair.
- Lift Stations – Drainage water flows through the system by gravity. There are low-lying areas where lift stations are used to pump the drainage water to a higher elevation. The water flows into a lift station at a low elevation, and is pumped to a higher level where it continues to flow through a pipe or channel. There are 13 lift stations in the drainage system.

The **Major Drainage System** is used when drainage water exceeds the capacity of the minor system and must flow over land. The major system is designed so that water will flow down roadways and land easements. Components of the major system include:

- Graded Roadways, Land Easements, Swales, and Lots – In order for the runoff water to flow over land to a point where it can be collected, the surface area must be properly sloped.
- Dry Bottom Detention Facilities – These are lower land areas constructed in open space areas such as parks. The detention facility contains outlets to and from the minor system. During periods of heavy rainfall, water that would otherwise overload the minor system enters the detention facility and is stored temporarily. The water from the detention facility then flows back into the minor drainage system at a later time when flows have gone down.
- Lake (or Wet) Retention Facilities – Lakes such as the ones in Lakeridge and Windsor Park are similar to dry bottom detention facilities, except they normally contain water all year for aesthetic reasons. When the minor system is overloaded, the water in these ponds rises, and then drops when the excess water flows back into the minor drainage system.
- Underground Detention Tanks – Underground detention tanks are also used, particularly in some of the downtown areas, to store excess water temporarily until it can be accommodated by the minor drainage system.

- Drainage Channels and Creeks – Drainage water empties into the drainage channels or Wascana Creek. The drainage channels function as very large drainage lines, with earthen banks used to control the water rather than enclosed pipelines. The drainage channels carry the runoff to Wascana Creek. Drainage from the Rowatt Flood Control Project south of Regina flows to Wascana Creek through constructed channel within the City Limits.

Although the major and minor systems are described as separate systems, they are part of an overall drainage system and must work in conjunction with each other. The systems are depicted in the map on the next page.

Drainage System Standards

Standards for drainage system design are normally expressed in terms of the size and type of storm a system can theoretically handle. For example, a drainage system may be designed to handle a 1:5 year storm, which means that it can handle the size of storm that statistically only occurs once in five years in the area. A drainage system designed to handle a 1:100 year storm would be able to handle the size of storm that statistically occurs once in 100 years in the area.

Statistical information is obtained from the Atmospheric Environment Service of Environment Canada to determine storm sizes. In the past, rainfall data was only available from the airport, but three additional data collection points have been added around the City since rainfall can vary significantly by area. Computer modelling is then done to determine the size of other storms.

The following are some of the major rainstorms that have occurred in Regina over the past 30 years:

June 1975	1:25 year storm
July 1983	1:100 year storm (108 mm of rain in four hours)
June 1994	1:25 year storm
August 1995	1:25 year storm (severe hail)
July 2001	1:100 year storm (50 mm in one hour)
August 2004	1:100 year storm (76 mm in one hour)
September 2010	1:10 year storm

Factors examined in determining the effective “size of storm” include:

- Total rainfall volume.
- Intensity of rainfall – a storm that drops 100 mm of rain in one hour is much more difficult to handle than one that drops 100 mm over six hours.
- Previous rainfall – if the ground is saturated before the storm, no additional water can soak in. Flows in the drainage system are therefore greater.



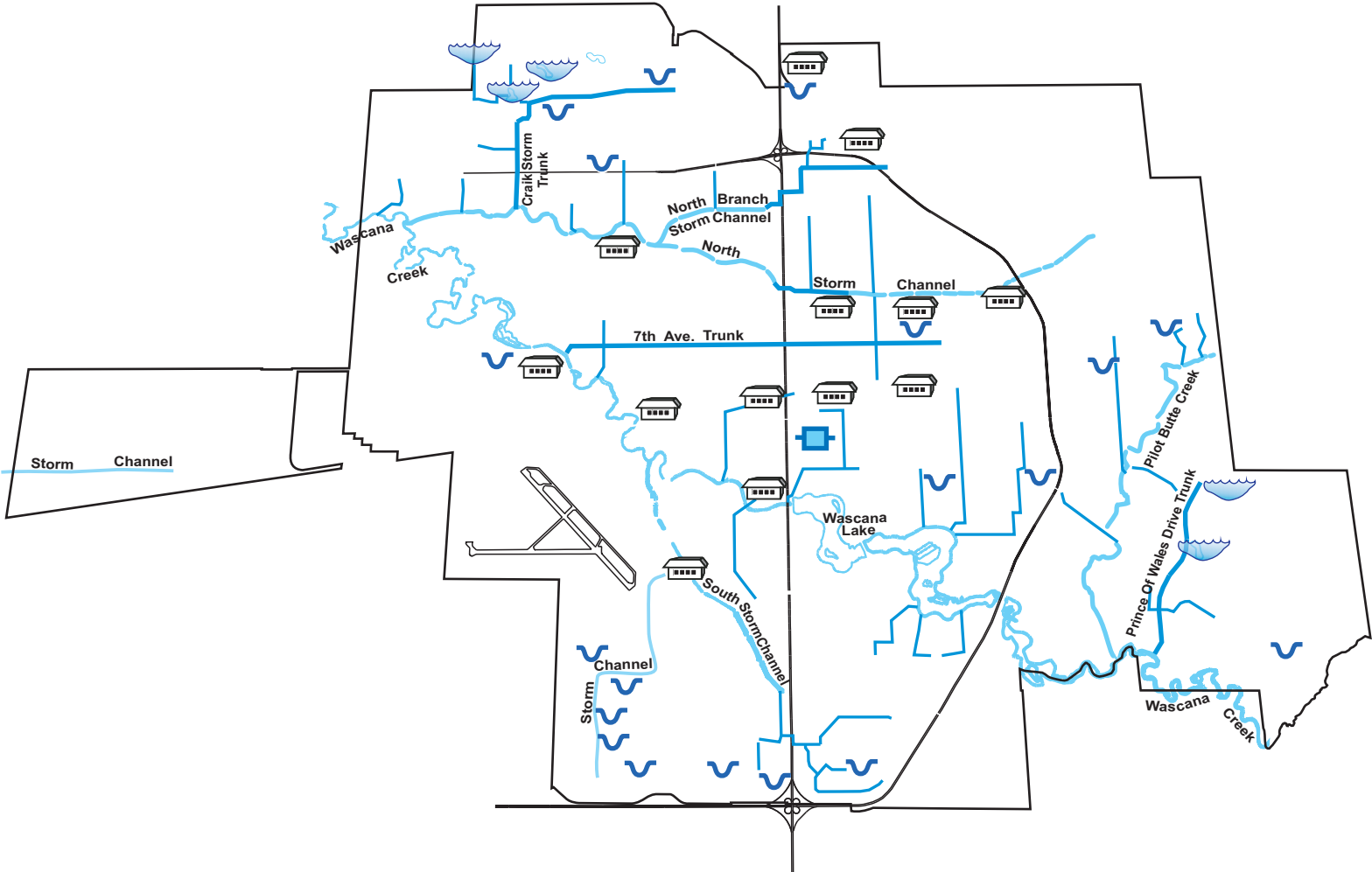

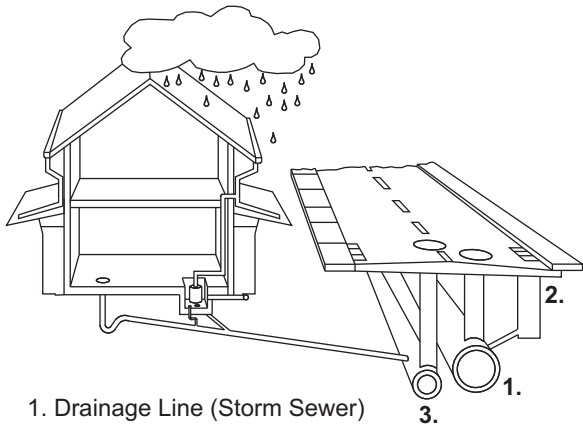

DRAINAGE SYSTEM



Drainage of a Residential Property



1. Drainage Line (Storm Sewer)
2. Catch Basin
3. Wastewater Collection Line

-  Lift Station
-  Retention Pond
-  Dry Bottom Detention
-  Underground Detention
-  Storm Sewer Main
-  Storm Channel

Standards for drainage systems have been raised over time, and have been applied to new developments. However, it is very costly to retroactively apply higher standards to existing development. Details of the standards include:

- **New Development Standards** – The “minor” drainage system consists of catch basins and underground lines that quickly collect and transport water. The “major” drainage system, consists primarily of aboveground facilities such as roadways, easements, swales, and detention and retention facilities that can handle larger volumes of water.

For new developments in the city, minor systems must be designed to handle a 1:5 year rainfall event. This corresponds with the general standard used across North America. While a higher standard would provide a higher level of service, the cost to construct underground facilities to handle larger storms is prohibitive. The major systems must be designed to handle a 1:100 year event.

- **Existing Development Standards** – The City has adopted a target of 1:5 year events for existing minor systems, and 1:25 year events for existing major systems. Some areas of the city do not meet these targets. In the early 1980s, a program to study the drainage problems was initiated to identify solutions and carry out remedial measures to mitigate drainage issues. A Drainage Master Plan designating 17 areas was adopted and consolidated and updated in 2009. Conditions in each area are assessed, problems identified and potential solutions proposed. Over time, work required to address the problems is carried out through the capital program.

Most of the property damage caused in Regina during intense rainstorms has been the result of basement flooding. The flooding was caused by runoff water entering the wastewater collection system, resulting in sewer overload and back up into basements. Although the drainage system is separate from the wastewater collection system, there are a number of ways stormwater can enter the wastewater collection system. These include:

- Some older buildings still have roof downspouts connected to the wastewater collection system.
- Runoff water on lots with poor grading adjacent to the building enters weeping tiles and collects in basement sump pits, which then drain into the wastewater collection system.

The City has established an objective to reduce direct connections between drainage and the wastewater collection system. An objective has also been established to reduce the runoff water entering the wastewater collection system from basement sump pits by educating homeowners about steps they can take to prevent such problems.

The most well designed system cannot function effectively unless it is properly maintained. To ensure the system functions as designed, the following objectives have been established:

- Drainage lines over 450 mm are regularly inspected and cleaned as required.
- Catch basins in areas where leaves are a problem are typically cleaned every two years and outlying areas are cleaned on a five-year cycle.

The North and South storm channels are an important part of the City of Regina’s storm water management system. The channel collects storm water from North and South Regina and discharges into the Wascana Creek which exits near the Joanne Goulet Golf Course on the northwest side of the City.

The storm channel is divided into sections such that the overall system is dredged on a 7-year cycle with a portion completed each year.

Dykes along Wascana Creek have been constructed and flood plains are maintained to contain creek flooding. The City’s objective is to prevent major damage to property and maintain public safety in the event

of flood conditions. Toward that end, monitoring is carried out during spring runoff to determine the risk of flood conditions and appropriate action is taken as necessary. The City has established an objective and capital plans to upgrade dykes to meet a 1:500 flood event level, the provincial standard. The upgrading of the dykes in Riverside was completed in 2005 and those in the Dieppe area were completed in 2007.

In addition to these initiatives, in 2009, the City amended Sewer Services Bylaw No. 5601 so that weeping tile flows are prohibited from entering the wastewater system in newer neighbourhoods under development. This will reduce the likelihood of wastewater backup in newer areas in heavy rainfall events.

Forecasting and Controlling Floods

Flood conditions on Wascana Creek are relatively rare. In 1996, high snowfall caused flood conditions along the creek. Creek flows were projected to be 85 cubic metres per second, or a 1:30 year flood. Although the actual peak levels were not as high as the initial predictions, it was necessary to take preventative action. Costs were incurred for labour and equipment for sandbagging and pumping water out of flooded areas, as well as repairs for some City owned structures damaged along the creek, such as the Pinkie Road Bridge. In 1999, flood control costs were incurred as a result of a large snow accumulation late in the winter, followed by a very quick spring thaw. The estimated creek flow was 40 cubic metres per second, or a 1:10 year event.

In 2011, well above normal snow fall and saturated ground conditions resulted in flood conditions along Wascana Creek. By the middle of April, creek flows were projected to be as high as 105 cubic metres per second, or a 1:50 year event. The actual peak flows reached as high as 75 cubic metres per second, the highest since the record flows of 1974 when peak flows reached 102 cubic metres per second. Although the actual peak flows were not as high as the initial predictions, it was necessary to take significant preventative action to protect property and ensure public safety. Major flood control costs were incurred for the labour and equipment required to produce and deploy temporary sandbag dykes and pumping water out of low lying areas.

Forecasting flood conditions involves communicating with provincial agencies regarding snow volumes and predictions for spring thawing. Early in the year, Saskatchewan Watershed Authority conducts assessments of the snow cover in the Wascana Basin, as well as other areas around Saskatchewan. As the spring thaw begins, water flows are measured throughout the creek system.

Budgets are prepared assuming spring runoff levels of an average year, where no special flood control measures are required like sand bagging and pumping behind the dykes when drainage line outlets are closed. The budget covers the cost of monitoring conditions on Wascana Creek and the drainage channels, as well as putting up barricades in areas where thin ice and water levels could pose a danger to the public.

Home Flood Protection Education Program

This program informs homeowners about the causes of basement flooding and the measures they should undertake on their property to prevent flooding damage from intense summer rainstorms. Information on home flood protection is available through the City's web page. Mitigation measures are required on both City and private property to accomplish neighbourhood service level improvements for managing large summer storm events and minimizing property damage and risk.

Engineering and Operations Administration

The majority of the information regarding water, wastewater and drainage services is provided in the preceding sections of this report. The operating budget summary includes costs related to Engineering and Operations Administration.

Objectives for the planning, design, operations and maintenance engineering include:

- **Long Range Planning** – In order to meet customer demands, water, wastewater and drainage systems require high levels of capital investment. It is necessary to anticipate and plan for future requirements so that the necessary future investment can be provided. To accommodate this, the following objectives have been established:
 - Long range capital plans (20 to 25 years) should be carried out regularly for each of the three major Utility systems.
 - Ongoing conditions should be monitored and the long range plans updated as new information becomes available.
- **Effective Management of Capital Program** – City Administration provide planning and design engineering services for the Utility. All capital projects should be completed within their approved standards, timelines and budgets.
- **Establishment of Construction Standards** – Standards are developed for all infrastructure construction, including those relating to the Utility systems. These standards are applied to construction carried out by City crews, contractors and developers. Over time, standards evolve as new construction techniques and materials become available. The objective of these standards is to meet legislation requirements, optimize performance, and minimize the life-cycle cost for the provision of the services.
- **Customer Awareness** – There are a number of areas within the Utility operations where customer actions can collectively affect service and costs. Information is provided to customers to increase awareness. Current programs include:
 - Water Conservation
 - Cross Connection Control and Backflow Prevention
 - Home Flood Proofing
 - Creekwatch
 - Wastewater Discharge Practices

Engineering and Project Management

The Water and Sewer Services Department, the Environmental Engineering Branch, and Development Engineering Department are responsible for planning, designing and supervising construction of the Utility systems infrastructure. A primary responsibility is overseeing the annual capital program. Projects carried out range from annual infrastructure renewal projects to less frequent major projects such as water treatment or wastewater treatment plant expansions. Engineering and design work may be done in-house or by external engineering firms. Construction work may be done by City Operations Division crews or by external contractors. The resources used for projects depend upon the nature of the project, the availability of resources, and the expertise required.

In 2012, reorganizational activities were started in both the City Operations and Community Planning and Development Divisions. This work will continue into 2013 and will see some Utility responsibilities move between various branches, departments and divisions.

Environmental Monitoring

Environmental monitoring activities include:

- Ground water monitoring at the wastewater treatment plant and downstream receiving body water quality.
- Surface water quality monitoring in the City's four retention lakes.
- Stormwater quality monitoring of urban drainage discharge to Wascana Creek and Wascana Lake.
- Snow dumpsite runoff monitoring.

Review of Development Proposals

Much of the City's water, wastewater and drainage systems are constructed by City staff, or by contractors under the direction of City. In the case of new development and re-development of existing areas, developers are responsible for constructing infrastructure including water, wastewater and drainage systems. This construction forms part of the Utility systems, and the City assumes responsibility for operation and maintenance of the systems.

Development proposals are reviewed by the Infrastructure Planning Branch (formerly part of the Development Engineering Department) to ensure design and construction meets City standards. Installations that do not meet City standards are identified and corrected by the developer. In late 2011, Development Engineering reintroduced subdivision inspectors to monitor the quality of work being completed to support the City's rapid rate of growth.

Technical and Engineering Support

City Operations Division technical and engineering staff provide support to the field personnel responsible for maintaining the water, wastewater and drainage systems, and for carrying out capital construction work for projects constructed by City personnel.

In addition, staff from both City Operations Division and Community Planning and Development Division provides construction scheduling, construction coordination and administrative and technical construction management services, which includes:

- Establishing, monitoring, and updating construction schedules.
- Coordinating construction with Utility companies.
- Tracking and monitoring expenditures of various capital projects.
- Estimating the costs of water and sewer construction projects.
- Reviewing and analyzing unit cost information.
- Provide quality and quantity control of construction work.

Customer Billing and Collection

Customer Service

Service Regina provides front line customer service for the Utility as well as other City services. This priority is applied to all aspects of operations, especially in contact with external customers, but also in dealings with internal customers and in responses to questions and requests for information. Objectives for customer service include:

- Customer applications for water services and disconnections are handled accurately.
- Customers can access information about their bill and receive prompt responses to their inquiries.
- Payments can be made using convenient payment methods.
- All service requests are processed within a reasonable time frame, given the nature of the service required.

Customer call centre volumes are monitored to ensure key performance indicators (KPI) are being met. The two primary KPIs are that calls are answered within 25 seconds, 80% of the time, and that abandoned calls are kept below 5%.

Customer service is accessible by telephone, mail, fax, in-person and electronically via the City's website. Internet requests and e-business inquiries continue to increase and this continues to be an area of focus. Continued awareness of customer needs to access information and services quickly and efficiently in the manner of their choosing is the focus of customer service efforts.

Service Regina's one-stop shop approach provides customers with information about the City's services through one central contact number. By directing customer calls to the area concerned, staff ensure that the customer is dealt with effectively and efficiently at their first point of contact.

Service Regina strives to ensure customer satisfaction on every occasion in the five essential elements of service: timeliness, knowledge and competency, courtesy, fair treatment and final outcome. When all five of these elements are in place, customers rate the services provided highly. The goal of the customer service area is to ensure satisfaction in every one of these areas with every customer.

Administration, Billing and Collection

Objectives for billing and collection include:

- Customers are billed every month.
- Customers receive accurate, timely, and informative bills.
- New payment methods are introduced where they can provide convenience to the customer, and where they are cost effective.
- Collection action is taken as required.
- Percentages of overdue accounts and uncollectible accounts are at a reasonable level.

The administration of customer accounts and the billing and collection function includes:

- Managing customer accounts, including setting up new customers, discontinuing accounts and transferring accounts from one individual to another. There is also a requirement to manage contracts with out-of-town water users who receive water from the City.
- Managing activities related to water meters includes obtaining meter readings and handling turn ons or turn offs of water service. Customers are divided into automated meter-reading routes so the meters are read according to a monthly schedule.

Water services must be connected and disconnected in response to customer requests and as a result of collection efforts.

- Generating customer bills – Customers are divided into billing cycles so each customer is billed every month.
- Collecting overdue customer accounts using a various collection tools. Interest is added to outstanding balances, which encourages timely payment. When accounts remain outstanding, payment arrangements are negotiated where possible. This includes maintaining a post-dated cheque database, as well as providing equalized payment options for Utility accounts.

Debt Management

This program includes the cost of principal and interest for debt issued to finance Utility capital projects, along with the cost of the debt issue. Debt charges are made up of two elements:

- Interest – This is the cost of interest payments on all outstanding debt.
- Principal repayments – These payments represent the cost to redeem the principal portion of the debt as it matures. The debt management program generally utilizes two forms of debt, either a serial debenture or a bullet debenture. A serial debenture is similar to a mortgage, where a portion of the principal amount of the debt is paid each year, along with interest, until the debt is fully repaid. Alternatively, a bullet debenture generally requires interest payments on a regular basis; however, the principal is only repaid at the end of the term.

The following table shows the existing annual debt charges and debt maturities.

Year	Annual Debt Charges (\$)	Debt Maturities		
		Debt Maturing (\$)	Per Cent of Total (%)	Cumulative Percentage Reduction (%)
2013	3,606.1	1,506	2.6	2.6
2014	45,920.1	44,606	77.5	80.1
2015	1,439.0	906	1.6	81.7
2016	1,402.3	906	1.6	83.2
2017	1,362.4	906	1.6	84.8
2018	1,320.1	906	1.6	86.4
2019	8,041.9	7,846	13.6	100.0
	Total	57,582	100.0	

In 2010, debt in the amount of \$42.4 million was reassigned from the GTH to fund the General Utility Reserve. As a result of the reassignment of this debt, no additional debt was required in 2010 to fund the Utility's capital program.

In 2012, approval was given to issue \$23.0 million in debt. Because of delays in capital investment, issuing of this debt has not yet been required. This approved debt is expected to be issued in mid-2013.

Additional debt will be required for the 2013 – 2017 Utility Capital Program in the amount of \$8.9 million in 2014, \$46 million in 2015 and \$51 million in 2016. In 2014, the GTH debt will mature and new debt of \$43.1 million will be required to replace it. This will result in a total debt requirement of \$52 million in 2014. The Utility Model includes funding for debt issuance costs and the repayment of projected debt issues based on a thirty year term and an interest rate of 4% for 2014, 4.2% for 2015, and 4.4% for 2016.

For further details on debt projections for future years, see Utility Capital Funding Section.

This page left blank intentionally.

Utility Capital Program

Utility Capital Program

Capital Program Summary

	2013	2014	2015	2016	2017	Five Year Total
Capital Expenditures (\$000's)						
Water Supply, Pumping & Distribution	16,896	28,800	21,965	21,630	18,115	107,406
Wastewater Collection & Treatment	5,435	68,605	59,505	67,105	21,605	222,255
Drainage	10,760	7,326	9,436	13,236	10,486	51,244
Other Utility Projects	5,939	2,565	2,965	4,675	1,595	17,739
Total Expenditures	39,030	107,296	93,871	106,646	51,801	398,644
Capital Funding (\$000's)						
General Utility Reserve	27,404	32,304	32,445	37,397	43,898	173,448
Service Agreement Fees - Utility Debt ¹	8,891	17,932	12,144	14,967	5,715	59,649
	-	52,000	46,000	51,000	-	149,000
External Contributions	2,735	5,060	3,282	3,282	2,188	16,547
Total Funding	39,030	107,296	93,871	106,646	51,801	398,644

Note:

1. The debt reassigned from the GTH is fully due in 2014. In that year, additional debt in the amount of \$43.1 million will be required to replace the reassigned GTH debt.

Infrastructure Overview

Regina has a substantial investment in utility infrastructure. A challenge for Regina, and other cities, is to generate sufficient funds to maintain these assets. The gap between the annual requirement to sustain the infrastructure and the annual investment is referred to as the "Infrastructure Gap". Regina is a relatively young city and has, to some extent, been shielded from the full impact of its utility infrastructure deficit since, until recently, much of the buried infrastructure was still within its expected service life.

In recent years, there has been increased discussion of the infrastructure deficit faced by cities, and the need for additional funding from the senior governments and/or alternate revenue sources for cities. The City has applied for funding under the Federal Green Infrastructure Fund to be used for the Wastewater Treatment Plant Expansion project. In 2013 the City will pursue funding opportunities as and when they become available.

The *Regina Development Plan, Bylaw No 7877* is the framework for land use and development decisions within the City of Regina. Implementation of the *Regina Development Plan* requires integration of infrastructure requirements into sector and concept plans, which detail the physical and engineering aspects of the new infrastructure along with funding and phasing of the work for Greenfield development. Current development policies are based on the provision of utility services provided in accordance with the Development Standards Manual. The development scenarios adopted in the *Regina Development Plan* result in significant infrastructure requirements and costs which are provided by the City in accordance with the Administration of Servicing Agreement Fees and Development Levies Policy adopted by Council.

Section 22.4 of *The Cities Regulations* requires Council to adopt a capital investment strategy that includes the method used for determining capital plans respecting the waterworks. Capital requirements (capital investment strategy) are determined based on engineering and planning studies that take into account the infrastructure requirements of the Utility required to meet the service goals of the Utility, as determined by City Council or prescribed by legislation. Infrastructure requirements are being addressed through a series of studies. Studies recently completed or underway include:

- The Wastewater Collection System Assessment Study, completed in 2004, estimated the replacement value of wastewater collection system as \$635 million. The estimated replacement value in current value is over \$850 million. The study defined requirements for the long-term sustainability of the wastewater collection infrastructure. In 2006, further work was done to investigate inflow and infiltration to the wastewater collection system and in 2010, a Citywide Wastewater Assessment was initiated which will be used to assess system performance, which may lead to recommended infrastructure improvements.
- The review of the Long Term Water Utility Plan was completed in 2006. It examines the present condition of Regina's water system, forecasts the requirements for the next 20 years and provides a plan for meeting future requirements. An estimate of the replacement value for the water distribution system at that time was \$300 million, with a further \$400 million for the supply system, including the City's share of the Buffalo Pound Water Treatment Plant.
- The 2009 consolidation of the drainage area reports into the Regina Drainage Master Plan Report indicated that it would require \$226 million (2008 dollars) to upgrade all areas of the city to meet a 1:25 year storm water detention standard. At the City's current rate of funding for detention upgrades, the study estimated that it would take 66 years to implement all the recommendations in the plan. This does not include operation, maintenance or life-cycle replacement. The study recommended that more funding be provided in order to implement the plan within 25 years.
- In 2007, the City of Regina partnered with the City of Saskatoon, for the development of a Buried Asset Repair Strategy. Approximately two-thirds of the water distribution and wastewater collection systems were constructed in a thirty-year period between the early 1950s and the late 1970s. In this period, almost all of the water distribution system construction used asbestos cement (AC) pipe. AC pipe has a reliable service life, under the conditions that prevail in Regina, of 50 years. In recent years, there has been an increasing frequency in breaks in asbestos cement pipe. This pattern will likely continue as the system ages and will put a financial strain on the Utility. The strategy is still under review and the City has developed criteria for piloting a replacement program.
- The value and infrastructure requirements of the wastewater treatment plant were documented through the Sewage Treatment Plant Planning Study. The final report was completed in late 2005. The initial Wascana Creek Receiving Environment Study was also completed in 2005. Both studies were used in developing capital plans for the wastewater treatment plant upgrade and to develop future plans to create a receiving environment water quality model.
- In 2011, the City of Regina initiated the pre-design study for the Wastewater Treatment Plant Upgrade Project. This project is required to meet new regulatory requirements as well as provide expanded hydraulic and process capability associated with future City growth. This study will select the treatment process design and provide updated cost estimates.
- The City is currently undertaking a comprehensive review of its Official Community Plan (OCP), which will replace the current Regina Development Plan, Bylaw No. 7877. As an input into the OCP, the City is completing Sector Serviceability Studies for each quadrant of the city. These studies will provide valuable information with respect to feasibility of providing water, wastewater and drainage service to potential future Greenfield areas of the city. The studies will also determine high level capital cost estimates with respect to providing those services, which will help guide the decisions regarding how and where the city will grow.

- In 2008, the City of Regina noted that water pressure in the Northwest quadrant was not adequate to allow development to continue in certain areas of the city. As a result, a Second Pressure Zone study was completed, which made recommendations for implementing another water pressure zone to provide service new areas and make improvements to water pressure in existing areas. The study also indicated that areas in the Northeast quadrant may require the implementation of a third pressure zone. The sector studies currently in progress will explore that recommendation.

These studies will contribute to determining the infrastructure gap.

Water Supply, Pumping and Distribution

Capital Summary (\$000's)	2013	2014	2015	2016	2017	Five Year Total
Capital Expenditures						
1. Water Supply						
- Buffalo Pound Water Treatment Plant Upgrades	10,000	18,500	12,000	12,000	8,000	60,500
- Reservoir Renewal Program	-	500	500	-	-	1,000
- Supply Line Improvements	-	900	750	750	1,500	3,900
2. Water Pumping						
- Water Pumping Stations Upgrades and Equipment Replacement	-	300	300	200	200	1,000
3 Water Distribution						
- Gordon Road Trunk Water Main Oversizing - 750 m west of Lewvan Drive to Campbell Street.	210	-	-	-	-	210
- Trunk Water Main - Chuka Boulevard from Green Apple Way to Primrose Green Drive to Arens Road	-	265	-	265	-	530
- Trunk Water Main - Fleet Street from Ross Avenue to Red Bear Avenue	400	-	-	-	-	400
- Trunk Water Main - Junor Drive from Pasqua Street to Rochdale Boulevard	900	-	-	-	-	900
- Future Water Distribution Main Oversizing	-	100	100	100	100	400
- Water Distribution Main Oversizing - Parliament Avenue from Harbour Landing Drive to Campbell Street	525	-	-	-	-	525
- Water Infrastructure Renewal	4,861	8,235	8,315	8,315	8,315	38,041
Total Expenditures	16,896	28,800	21,965	21,630	18,115	107,406
Capital Funding						
General Utility Reserve	10,976	9,934	9,865	9,265	14,907	54,947
Service Agreement Fees - Utility	3,185	2,493	1,480	1,745	1,020	9,923
Debt	-	11,313	7,338	7,338	-	25,989
External Contributions	2,735	5,060	3,282	3,282	2,188	16,547
Total Funding	16,896	28,800	21,965	21,630	18,115	107,406

Water Supply

Current Year Programs

Buffalo Pound Water Treatment Plant Upgrades

Improvements to replace and expand the facility and equipment are required at the Buffalo Pound Water Treatment Plant to ensure there is sufficient capacity and ability to continue to: meet regulatory requirements, protect public health and safety; and ensure sufficient reliable supply that meets quantity and quality expectations of a growing Community. Improvements will address the impacts of aging infrastructure, regulatory changes, changes in engineering and building standards, industry best practises to protect public health and safety, and growth within the community. This program typically includes inspection, assessment, replacement and rehabilitation work at the Plant and/or Lake. In 2013, funding is provided by the City of Regina's Utility Reserve (61.15%), Utility Servicing Agreement Fees (11.5%) and external contributions from the City of Moose Jaw (27.35%).

Future Years Planned Programs

Reservoir Renewal Program

The City's reservoirs require inspection, rehabilitation and upgrading to maintain expected level of service and ensure the reliability and safety of the water supply system. This program typically includes inspection, assessment, replacement and rehabilitation of water reservoirs and associated equipment and infrastructure. The Utility Reserve funds this work.

Supply Line Improvements

This program inspects, repairs, and replaces main valves, valve structures and other miscellaneous work on the Buffalo Pound supply pipeline and other major supply mains within the City. As the pipelines age, improvements are necessary to ensure the reliability of the water supply to the City and reduce the number of emergency repairs. The Utility Reserve funds this work.

Water Pumping

Future Years Planned Programs

Water Pumping Stations Upgrades and Equipment Replacement

The City's water pumping stations require ongoing upgrading of equipment and components to continue to provide a reliable water supply. This program includes inspection, assessment, replacement, and rehabilitation work at the water pump stations. Funding is provided from the Utility Reserve.

Water Distribution

Current Year Programs

Gordon Road Trunk Water Main Oversizing - 750 m West of Lewvan Drive to Campbell Street

This project provides a rebate to oversize the trunk water main along Parliament Avenue from 750 m West of Lewvan Drive to Campbell Street to service the area West of Campbell Street. This project is 100% funded from Utility Servicing Agreement Fees.

Trunk Water Main - Fleet Street from Ross Avenue to Red Bear Avenue

This project provides for the detailed design and construction of a trunk water main along Fleet Street from the City Loop at Ross Avenue to Red Bear Avenue. This project is 100% funded from Utility Servicing Agreement Fees.

Trunk Water Main – Junor Drive from Pasqua Street to Rochdale Boulevard

This project provides for the installation of approximately 1400 m of 400 mm diameter trunk water main along Junor Drive. This project is 100% funded from Utility Servicing Agreement Fees.

Water Distribution Main Oversizing – Parliament Avenue from Harbour Landing Drive to Campbell Street

This project provides a rebate to oversize the water distribution main along Parliament Avenue from Harbour Landing Drive to Campbell Street. This project is 100% funded from Utility Servicing Agreement Fees.

Water Infrastructure Renewal

The underground water distribution system requires ongoing rehabilitation and upgrading to maintain expected level of service and ensure the reliability and safety of the water distribution system. This

program typically includes inspection, assessment, replacement, rehabilitation and upgrading of water distribution mains, fire hydrants, service connections, and other appurtenances and associated structures. The Utility Reserve funds this program.

Future Years Planned Programs

Trunk Water Main – Chuka Boulevard from Green Apple Way to Primrose Green Drive to Arens Road

This project provides for the detailed design and construction of a of trunk water main along Chuka Boulevard from Green Apple Way to Arens Road to service the Greens on Gardiner subdivision and support potential development to the North of the Greens on Gardiner within the 235,000 population growth scenario. This project is 100% funded from Utility Servicing Agreement Fees.

Future Water Distribution Main Oversizing

This program provides for the construction of new water distribution mains requiring oversizing to allow for distribution of water to future developments beyond the concept plan area. This project is 100% funded from Utility Servicing Agreement Fees.

Wastewater Collection and Treatment

Capital Summary (\$000's)	2013	2014	2015	2016	2017	Five Year Total
Capital Expenditures						
1. Wastewater Treatment:						
- Wastewater Treatment Plant Upgrade	-	48,000	48,000	56,900	-	152,900
- Wastewater Treatment Plant Improvements	50	50	50	50	-	200
- Wastewater Treatment Plant Refurbishing	2,000	250	200	200	-	2,650
- Wastewater Treatment Plant Capital Maintenance	500	500	500	500	500	2,500
- McCarthy Boulevard Pumping Station Upgrade	-	-	-	-	2,000	2,000
- Waste Hauler Dump Station	-	7,000	1,500	-	-	8,500
2. Wastewater Collection:						
- 7th Avenue Storm and Domestic Sewer Cleaning	300	-	-	-	-	300
- Garnet Street Lift Station Pump Upgrade	100	-	-	-	-	100
- Sanitary Trunk Main - Gordon Road from Aerodrome to Campbell Street	600	500	-	-	-	1,100
- Harbour Landing Sewage Force Main Extension	-	-	-	200	1,000	1,200
- Jetting Equipment Upgrades	80	-	-	-	-	80
- Lift Station Upgrade	-	400	350	350	200	1,300
- New Connector Trunk and Lift Station	-	-	-	-	9,000	9,000
- Sanitary Trunk Main - Chuka Boulevard from Green Apple Way to Greens on Gardiner North Boundary	625	625	-	-	-	1,250
- Future Sewer Collection Mains Oversizing	-	100	100	100	100	400
- Sewer Connection Replacement	680	680	680	680	680	3,400
- Southeast Pump Station Storage	500	3,500	-	-	-	4,000
- Wastewater Infrastructure Renewal	-	7,000	8,125	8,125	8,125	31,375
Total Expenditures	5,435	68,605	59,505	67,105	21,605	222,255
Capital Funding						
General Utility Reserve	3,701	12,628	10,179	10,621	18,885	56,014
Service Agreement Fees - Utility	1,734	15,289	10,664	12,822	2,720	43,230
Debt	-	40,687	38,662	43,662	-	123,011
Total Funding	5,435	68,605	59,505	67,105	21,605	222,255

Wastewater Treatment

Current Year Programs

Wastewater Treatment Plant Upgrade

The Wastewater Treatment Plant Upgrade project is currently in progress, with funding allocated prior to 2013. The chart below provides a summary of the costs for this project, including the expected impact of inflations, with a total expected project cost of \$207 million:

Wastewater Treatment Plant Summary of Costs	Prior Year Funding	2013	2014	2015	2016	Total
Expected Capital Cost (in 2013 dollars)	27,500	-	48,000	48,000	56,900	180,400
Inflation	-	-	3,840	7,980	14,780	26,600
Total Project Cost	27,500	-	51,840	55,980	71,680	207,000

In order to maintain operating condition, meet future growth needs and new provincial regulatory requirements, a major upgrade of the Wastewater Treatment Plant is required. Work involves concept development undertaken in 2011, design engineering in 2012/2013, equipment procurement, and

installation construction contracts over a multiple year project schedule. There will be phases of development, with short term, obvious upgrades or immediately identifiable solutions moving forward more quickly to maintaining current operations. Funding will be provided from Utility Servicing Agreement Fees (22%) and the remaining 78% from the Utility Reserve and Debt financing.

Wastewater Treatment Plant Improvements

The Wastewater Treatment Plant requires improvements to the grit removal system, valve chamber, lagoon system and UV Disinfection System. Funding is provided from the Utility Reserve (91.25%) and Utility Servicing Agreement Fees (8.75%).

Wastewater Treatment Plant Refurbishing

This project provides funding for major maintenance projects beyond regular operating and maintenance budget works to refurbish various areas of the Wastewater Treatment Plant, including administration, laboratory, lagoons, primary treatment plant, sludge dewatering, tertiary treatment plant, and the site. The Utility Reserve funds this program.

Wastewater Treatment Plant Capital Maintenance

This project provides funding for minor capital maintenance required to maintain expected level of service and support the ongoing operation of the Wastewater Treatment Plant.

Future Years Planned Programs

McCarthy Boulevard Pumping Station Upgrade

McCarthy Boulevard Pumping Station requires upgrades involving building repairs, pumping, screens for removal of solids and debris, HVAC/electrical components, and additions of an odour abatement system to continue to provide reliable wastewater conveyance to the Wastewater Treatment Plant. Funding is from the Utility Reserve (85%) and Utility Servicing Agreement Fees (15%).

Waste Hauler Dump Station

This project provides for the development of a permanent Waste Hauler Dump Station at the Wastewater Treatment Plant. In the past waste hauler trucks discharged sewage at the McCarthy Boulevard Pumping Station. Upgrades at the pumping station resulted in the relocation of the discharge to a temporary location at the Waste Water Treatment Plant. Planning for a future station has identified locations and construction options. A majority of waste haulers are servicing rural customers and the City is currently working with the RM of Sherwood to address the station from a regional perspective. This project is currently funded from the Utility Reserve with additional funding to be provided from sharing agreements. It is intended that revenue from the facility will recover construction and operating costs.

Wastewater Collection

Current Year Programs

7th Avenue Storm and Domestic Trunk Cleaning

This project provides for the cleaning of the 7th Avenue Storm Trunk and 7th Avenue Domestic Sewer Trunk. This program is funded from the Utility Reserve.

Garnet Street Lift Station Pump Upgrade

This project provides for the full replacement/renewal of existing pumps in this domestic lift station. This program is funded from the Utility Reserve.

Sanitary Trunk Main - Gordon Road from Aerodrome to Campbell Street

This project involves the construction of a deep sanitary trunk sewer along Gordon Road from Aerodrome Road to Campbell Street Funding for this project is 100% provided from Utility Servicing Agreement Fees.

Jetting Equipment Upgrades

The City's wastewater collection system requires new equipment for the ongoing inspection, assessment and maintenance of an expanding wastewater collection system. This program includes the purchase of equipment used in the operation and maintenance of the wastewater collection system. Funding is provided from the Utility Reserve.

Sanitary Trunk Main - Chuka Boulevard from Green Apple Way to Greens on Gardiner North Boundary

The project provides for the extension of the sanitary trunk main to service North portions of Greens on Gardiner and future development of the Towns. Funding for this project is 100% provided from Utility Servicing Agreement Fees.

Sewer Connection Replacement

This program provides funding for maintenance, inspection and rehabilitation of sewer connections to maintain expected levels of service and ensures the reliability of the sanitary sewer system to individual customers. This program typically replaces the City side of sewer connection that have reached the end of their service life or cannot be economically repaired. The Utility Reserve funds this program.

Southeast Pump Station Storage

This project involved expansion of the existing storage for the Creeks Pump Station located in the Southeast required for future new development in the Southeast. Funding for this project is 100% provided from Utility Servicing Agreement Fees.

Wastewater Infrastructure Renewal

The Wastewater Infrastructure Renewal Program is currently in progress with funding allocated prior to 2013. The wastewater collection system requires ongoing rehabilitation and upgrading to maintain and improve the level of service and to ensure the system's reliability. This program includes inspections, assessments, relining, replacement, and rehabilitation. The condition assessment and rehabilitation is done both in conjunction with scheduled roadway renewal projects and proactive locations identified in the system. The Utility Reserve funds this program.

Future Years Planned Programs

Harbour Landing Forcemain

This project includes extension of the wastewater forcemain from the Harbour Landing Pump Station future build-out of Harbour Landing. Funding for this project is 100% provided from Utility Servicing Agreement Fees.

Lift Station Upgrade

The City's wastewater pumping stations are aging and require upgrading to restore or improve the level of service and to reduce emergency repair costs. This program will include assessment, pre-design, rehabilitation, upgrades and/or replacement of existing pumping stations. The Utility Reserve funds this program.

New Connector Trunk and Lift Station

Funding will be used for the assessment, design and construction of a new connector trunk, lift station and other related components to improve the functioning of the wastewater collection system.

Future Sewer Collection Mains Oversizing

This program provides for the construction of new sewer collection mains requiring oversizing within new subdivisions for future developments. Funding for this project is 100% provided from Utility Servicing Agreement Fees.

Drainage

Capital Summary (\$000's)	2013	2014	2015	2016	2017	Five Year Total
Capital Expenditures						
1. Drainage Systems:						
- Area 2B (Albert Park Detention)	-	3,800	-	-	-	3,800
- Area 5 Upgrades	-	500	-	-	-	500
- Area 6 Upgrades	-	-	400	-	1,500	1,900
- Area 8 Upgrades	250	-	600	-	-	850
- Area 10 Upgrades	-	450	-	-	3,000	3,450
- Area 14 Upgrades	-	450	-	2,000	-	2,450
- Area 1 & 17 Upgrades	-	-	-	2,500	1,500	4,000
- Drainage Pumping Station Upgrading	-	-	375	375	200	950
- Area 13 A (Highland Park/Cityview)	-	-	4,500	4,500	-	9,000
- Detention Pond - South of Regina Memorial Gardens	200	-	-	-	-	200
- Detention Pond (A) - North of CPR line and West of Winnipeg Street	-	-	-	-	250	250
- Southeast Quadrant Detention (Victoria Avenue Interchange)	6,000	-	-	-	-	6,000
- Drainage Infrastructure Renewal	-	1,676	3,161	3,161	2,111	10,109
- Dykes, Drainage Channels and Lake Improvements	500	400	400	400	200	1,900
- Ross Industrial Park - Phase 1 Stormwater Management	650	-	-	-	-	650
- Greens on Gardiner Detention Pond (MR2)	500	-	-	-	-	500
- Greens on Gardiner Detention Pond (MR3)	700	-	-	-	-	700
- Greens on Gardiner Storm Sewer - Green Water Drive from Green Apple Drive to Green Brook Way	100	50	-	-	-	150
- Harbour Landing Detention Pond (MR10) - James Hill Road and Tudor Way	300	-	-	-	-	300
- Harbour Landing Detention Pond (MR7) - West of the Storm Channel and South of Gordon Road	110	-	-	-	-	110
- Harbour Landing Detention Pond (MR8 & MR9) - West of Storm Channel and South of Gordon Road (MR8); North of Gordon Road (MR9)	950	-	-	-	-	950
- Hawkstone Detention Pond (F) - West of Argyle Street and South of Rochdale Boulevard	-	-	-	300	-	300
- Northeast Industrial Development - SW detention	500	-	-	-	-	500
- The Greens on Gardiner and the Towns - Detention Pond and Drainage Route	-	-	-	-	1,725	1,725
Total Expenditures	10,760	7,326	9,436	13,236	10,486	51,244
Capital Funding						
General Utility Reserve	6,850	7,276	9,436	12,936	8,511	45,009
Service Agreement Fees - Utility	3,910	50.0	-	300.0	1,975	6,235
Total Funding	10,760	7,326	9,436	13,236	10,486	51,244

Drainage

Current Year Programs

Area 8 Upgrades (Douglas Place) revised from Assiniboia East

This project will upgrade the drainage system in Area 8 (Assiniboia East) to improve the desired drainage level of service in the area. Funding for this program is provided from the Utility Reserve.

Detention Pond South of Regina Memorial Gardens

This project will provide for construction of a Detention Pond East of Regina Memorial Garden Cemetery. The project is 50% funded from Utility Servicing Agreement Fees and 50% funded from General Utility Reserve

South East Quadrant Detention (Victoria Avenue Interchange)

This is part 3 of 3 Glencairn Stormwater Management Improvement Projects. Upgrading the detention of the SE Quadrant in the Victoria Avenue and Highway 1 Interchange will improve the drainage level of service in the underpass. The Utility Reserve funds this project.

Drainage Infrastructure Renewal

The Drainage Infrastructure Renewal Program is currently in progress with funding allocated prior to 2013. The drainage system requires ongoing rehabilitation and upgrading to maintain and improve the level of service and to ensure the system's reliability. This program includes inspections, assessments, relining, replacement, and rehabilitation. The condition assessments may be done in conjunction with scheduled roadway renewal projects or proactively at locations as warranted. The Utility Reserve funds this program.

Dykes, Drainage Channels and Lake Improvements

This program rehabilitates and improves the level of service of facilities such as dykes, channels, streams, lakes and ponds. Periodic assessments, repairs, modifications and improvements are required to ensure the integrity and capacity of these systems. The Utility Reserve funds this program.

Ross Industrial Park - Phase 1 Storm water Management

The project provides funding for the construction of stormwater detention facilities including storm sewers West of Fleet Street and South of the CN Railway. This project is 100% funded from Utility Servicing Agreement Fees.

Greens on Gardiner Detention Pond (MR 2)

This project provides for the construction of detention pond MR 2 in Greens on Gardiner including excavation, outlet pipe, trunk sewer and coarse grass seeding for a detention pond. This project is 100% funded from Utility Servicing Agreement Fees.

Greens on Gardiner Detention Pond (MR 3)

This project provides for construction of detention pond MR 3 in Greens on Gardiner (Phase 2, Stage 1) North of Arcola Avenue. This project is 100% funded from Utility Servicing Agreement Fees.

Greens on Gardiner Storm Sewer (Green Water Drive North of Green Apple Drive)

This project provides for construction of storm sewer for Greens on Gardiner Green Water Drive from Green Apple Drive to Primrose Green Drive. This project is 100% funded from Utility Servicing Agreement Fees.

Harbour Landing Detention Pond (MR10) – James Hill Road and Tutor Way

This project is for the construction of detention pond MR10 in Harbour Landing near James Hill Road and Tutor Way. The project includes design and construction for the excavation, outlet and landscaping. The project is funded 100% from Utility Servicing Agreement Fees.

Harbour Landing Detention Pond (MR7) – West of the Storm Channel and South of Gordon Road

This project is for the construction of detention pond MR7 in Harbour Landing, West of the Storm Channel and South of Gordon Road, as part of the storm water management infrastructure for the area. The project includes design and construction for the excavation, outlet and landscaping. This project is 100% funded from Utility Servicing Agreement Fees.

Harbour Landing Detention Pond (MR8 and MR9) – West of the Storm Channel

This project is for the construction of detention ponds in Harbour Landing, West of the Storm Channel and South of Gordon Road (MR8) and West of the Storm Channel and North of Gordon Road (MR9), as part of the storm water management infrastructure for the area. The project includes design and construction for the excavation, outlet and landscaping. This project is 100% funded from Utility Servicing Agreement Fees.

Northeast Industrial Development- Detention

Construction of a detention pond for industrial development East of Fleet Street. The work involves construction of storm sewers, excavation and coarse grass seeding. This project is 100% funded from Utility Servicing Agreement Fees.

Future Years Planned Programs**Area 2B (Albert Park Detention)**

This project will provide improvement for the drainage level of service in the Albert Park area. 2013 funding will be used to construct drainage improvement systems. The Utility Reserve funds this program.

Area 5 Upgrades (Glencairn)

This project will upgrade the drainage system in Area 5 to improve the desired drainage level of service in the area. Funding for this program is provided from the Utility Reserve.

Area 6 Upgrades (Argyle Park)

This project will upgrade the drainage system in Area 6 to improve the desired drainage level of service in the area. Funding for this program is provided from the Utility Reserve.

Area 10 Upgrades (Core Park)

This project will upgrade the drainage system in Area 10 to improve the desired drainage level of service in the area. Funding for this program is provided from the Utility Reserve.

Area 14 Upgrades (Lakeview)

This project will upgrade the drainage system in Area 14 to improve the desired drainage level of service in the area. Funding for this program is provided from the Utility Reserve.

Area 1 & 17 Upgrades (North Central & Rosemount)

This project will upgrade the drainage system in Area 1 & 17 to improve the desired drainage level of service in the areas. The Utility Reserve funds this program.

Drainage Pumping Station Upgrading

The City's drainage pumping stations are aging and require upgrading to restore or improve the level of service and to reduce emergency repair costs. This program will include assessment, documentation, prioritization, pre-design, rehabilitation, upgrades and/or replacement of existing pumping stations. The Utility Reserve funds this program.

Area 13A (Highland Park/Cityview)

This program will upgrade the drainage system in Highland Park to improve the desired drainage level of service in the area. Funding is provided from the Utility Reserve.

Detention Pond (A) - North of CPR line and West of Winnipeg Street

This project will construct the detention pond (A) as identified in the North West Sector Serviceability Study, North of the CPR line and West of Winnipeg Street, as part of the storm water management infrastructure for the area. The project includes design and construction for the excavation, outlet and landscaping. The project is 100% funded from Utility Servicing Agreement Fees.

Hawkstone Detention Pond (F) – West of Argyle Street and South of Rochdale Boulevard

This project will construct the detention pond (F) as identified in the Northwest Sector Serviceability Study, located West of Argyle Street and South of Rochdale Boulevard, as part of the storm water management infrastructure for the area. The project includes design and construction for the excavation, outlet and landscaping. This project is 100% funded from Utility Servicing Agreement Fees.

The Greens on Gardiner and the Towns - Detention Pond and Drainage Route

This project provides for the design and construction of a detention pond and drainage channel or storm trunk main to Chuka Creek in the Greens on Gardiner and the Towns subdivisions. The project includes design and construction for the excavation, outlet and landscaping. This project is 100% funded from Utility Servicing Agreement Fees.

Other Utility Projects

Capital Summary (\$000's)	2013	2014	2015	2016	2017	Five Year Total
Capital Expenditures						
1. Other Utility Projects						
- Utility Billing Equipment Replacement Upgrade	-	20	20	40	20	100
- Development of the Official Community Plan	266	-	-	-	-	266
- Infrastructure Communications/SCADA Upgrades	80	-	-	-	-	80
- Future Equipment Purchases	-	150	150	150	150	600
- Mobile Equipment Enclosed Parking	360	-	-	-	-	360
- ITS Infrastructure - Utility Portion	325	325	325	325	325	1,625
- Sewer System Equipment	80	-	-	-	-	80
- Water Distribution System Equipment	75	-	-	-	-	75
- Sustainable Infrastructure - Water, Wastewater & Drainage Studies & Pilot Projects	-	100	-	100	-	200
- Wastewater Treatment Plant Operations & Maintenance Building	2,700	1,000	-	-	-	3,700
- Meter Installation Program	500	500	500	500	500	2,500
- City Operations Facilities	200	70	1,670	3,260	-	5,200
- Trench Settlement Remediation	300	300	300	300	300	1,500
- Trunked Radio System User Gear Replacement	293	-	-	-	-	293
- Utility Billing System Upgrade	100	100	-	-	300	500
- City Hall Elevator Modernization	660	-	-	-	-	660
Total Expenditures	5,939	2,565	2,965	4,675	1,595	17,739
Capital Funding						
General Utility Reserve	5,872	2,465	2,965	4,575	1,595	17,472
Service Agreement Fees - Utility	67	100	-	100	-	267
Total Funding	5,939	2,565	2,965	4,675	1,595	17,739

Other Utility Projects

Current Year Programs

Development of the Official Community Plan

This project will result in a new Official Community Plan (OCP) for Regina, replacing the Regina Development Plan. The OCP will describe what kind of city Regina intends to become and include a policy framework that will guide how it will get there in the context of the City's physical, environmental, economic, social, and cultural development. The utility component of this project is funded from the Utility Reserve (75%) and from Utility Servicing Agreement Fees (25%).

Infrastructure Communications/SCADA Upgrades

This project provides funding for Instrumentation and communication initiatives to support infrastructure additions and purchase and integration of SCADA equipment to support operational and maintenance requirements. This program is funded from the Utility Reserve.

Mobile Equipment Enclosed Parking

Enclosed indoor parking, both heated and unheated, is required for light trucks and equipment. Enclosed parking will provide better access as well as protecting water-filled accessories from freezing and from vandalism. This project includes space rental, Building F extension and pit relocation. Funding is provided from the Utility Reserve.

ITS Infrastructure - Utility Portion

This program provides for the Utility contribution to IT projects that support the Utility as approved in the General Capital Program. Funding is provided from the Utility Reserve.

Sewer System Equipment

This project provides funding for field technology improvements for the jet and sewer service area to improve efficiency of data-handling in the field as well as effectiveness in cold-weather conditions. This program is funded from the Utility Reserve.

Water Distribution System Equipment

The City's water distribution system requires new equipment for the ongoing inspection, assessment and maintenance of an expanding water distribution system. This program includes the purchase of equipment used in the operation and maintenance of the water distribution system. Funding is provided from the Utility Reserve.

Waste Water Treatment Plant Operations and Maintenance Building

This project provides for construction of a new operations and maintenance building and office space at the Wastewater Treatment Plant, including site work, building construction, parking, security, consulting fees, permits and reports. Funding is provided from the Utility Reserve.

Meter Installation Program

The City's expanding community requires the installation of water meters in new homes. This program includes the purchase and installation of new water meters for new construction. Funding is provided from the Utility Reserve.

City Operations Facilities

Capital improvements for the design and construction of interim works identified in the Public Works Facilities Master Plan. Also includes funding to provide and renovate interim space to house staff to support the delivery of the capital program prior to major renovations. Funding is provided from the Utility Reserve.

Trench Settlement Remediation

Cracking and settling of sidewalks, curbs, gutter and pavement occur as a result of backfill settlement at watermain work locations, resulting in drainage problems. This program corrects settlement at these locations. The Utility Reserve funds this program.

Trunked Radio System User Gear Replacement

Trunked Radio System Infrastructure Upgrade will require new user gear (portable and mobile radios) as existing gear will not work on the new Infrastructure. This program is funded from the Utility Reserve.

Utility Billing System Upgrade

The upgraded version of the Utility Billing system has significant new functionality, including e-billing, electronic work queue, customer contact tracking, and dispatch functionality. This project provides for the review of the improved functionality of the system and implementation of selected functionality. Funding is provided from the Utility Reserve.

City Hall Elevator Modernization

This project includes an upgrade to the existing elevators with modernized electrical and mechanical components. The existing elevators are original to the building and require frequent maintenance. Elevator 1 also needs to be upgraded to freight status. Upgrades will provide improved elevator service and efficiency while reducing energy consumption through the destination dispatch intelligence. Includes security upgrades to coincide with the main floor renovation at City Hall. This expenditure, funded from the Utility Reserve, represents 40% of the total project cost.

Future Years Planned Programs

Utility Billing Equipment Replacement Program

In order to obtain readings from AMR meters, the City has deployed a number of hand-held and vehicle-mounted (VXU) radio-read devices. These devices, along with other larger equipment used in the Utility Billing operation, such as curb box locators, are warranted and can be repaired and upgraded for a period of time, but in order to manage upgrades effectively a consistent program is more appropriate. This program is funded from the Utility Reserve.

Future Equipment Purchases

As equipment requirements change within the utility, additional or new specialized pieces of equipment are required to manage ongoing operations. This program is intended to operate as a placeholder for the purposes of planning in the Utility Model and is based on average expected new or specialized equipment purchases based on previous five year history. Funding is provided from the Utility Reserve.

Sustainable Infrastructure - Water, Wastewater and Drainage Studies and Pilot Projects

This project encompasses pilot projects and studies pertaining to water distribution, wastewater collection and stormwater infrastructure. Projects and studies will be used to determine the future viability of new or innovative sustainable solutions to the City of Regina, which may be ultimately incorporated into future development policy, guidelines and specifications. Studies or pilots will be focused within new growth areas and will either be independent or augment new infrastructure construction. Funding for this project is 100% provided from Utility Servicing Agreement Fees.

Utility Capital Funding

Funding for the Water and Sewer Utility Capital Program is primarily from the following sources:

- General Utility Reserve.
- Utility Servicing Agreement Fees and Development Levies.
- Federal and Provincial Infrastructure Programs (no funding currently in the five year program).
- Debt.

General Utility Reserve

The General Utility Reserve is funded through the operating surplus of the Utility. Each year the Utility generates a surplus, a portion of which is transferred to the general operating and capital budgets, with the balance transferred to the General Utility Reserve. The reserve is primarily used to fund capital projects, but is available should there be an operating shortfall. At present, a significant surplus in the General Utility Reserve is required to offset the shortfall in the Utility Servicing Agreement Fee Reserve. The following table provides a projection for the General Utility Reserve.

<u>General Utility Reserve (\$000's)</u>					
	2013	2014	2015	2016	2017
Reserve Balance - Start of Year¹	63,165	75,618	34,451	30,429	10,917
Net Operating Surplus	40,153	40,987	40,531	39,023	39,023
Transfer to Technology reserve	(300)	(300)	(300)	(300)	
Replacement of Debt ²	-	(43,100)	-	-	-
Capital Program Requirement (in 2013 dollars) ³	(27,400)	(32,304)	(32,445)	(37,397)	(43,898)
Impact of Inflation on Capital Program ⁴	-	(6,450)	(11,808)	(20,838)	(9,577)
Reserve Balance - End of Year	75,618	34,451	30,429	10,917	(3,535)

Note:

1. The General Utility Reserve beginning balance has been revised from \$49 million to \$74 million due to the following:
 - Review of the Capital carry-forward resulting in project dollars being returned to the Reserve during the latter part of 2012;
 - Increased Revenue Projections; and,
 - Unexpended dollars from other projects being completed in 2012.
2. The debt reassigned from the GTH is fully due in 2014. In that year, additional debt in the amount of \$43.1 million will be required to replace the reassigned GTH debt.
3. The Capital Program Requirement reflects an estimated inflation rate applied to capital requirements. The 2013 – 2017 Utility Capital Program is presented in current dollars (without inflation). The Utility model incorporates projected increases in revenues and expenditures due to inflation. The net operating surplus reflects future projected increases and as such, the inflationary projection for capital program requirements is also used in this table.
4. Impact of inflation on capital program includes the impact of inflation for all projects funded through the General Utility Reserve or through debt. The impact of inflation on projects funded through Utility Servicing Agreement fees is found in the section on Servicing Agreement Fees and Development Levies below.

Servicing Agreement Fees and Development Levies

Servicing Agreement Fees (SAF) and Development Levies (levies) are pursuant to *The Planning and Development Act, 2007* and are collected when a servicing agreement or development levy agreement is entered into between the City and a developer. The agreements require a payment to the City of a predetermined amount per hectare of land within the development area. The funds are intended to be used towards the construction of infrastructure to support new development.

In the case of utility related costs for development, the City normally incurs the costs of providing infrastructure prior to the full development of an area and then recovers the costs through the development charges as the area develops.

For 2013, the Utility Servicing Agreement Fees/Development Levies are set at \$124,842 per hectare of land within the development area. The payment schedule requires 30% upon execution of a servicing agreement, another 40% within nine months and the balance within a further nine months. Eligibility of funding is by policy of City Council.

Revenue from SAF and levies is recognized when the funds are spent on an eligible project. Historically, capital projects eligible for SAF funding have been undertaken ahead of the funds being available resulting in a shortfall in Servicing Agreement Fees funding. This shortfall is funded through the surplus in the General Utility Reserve. The projections have been based on information provided by the development community, and estimates from Development Engineering for 2013 to 2017 and assume that fees are collected on 80 hectares per year, in accordance with the SAF/Levy rate calculation.

	<u>Servicing Agreement Fees (\$000's)</u>				
	2013	2014	2015	2016	2017
Balance - Start of Year	(34,735)	(34,848)	(44,228)	(47,806)	(54,805)
Servicing Agreement Fees ¹	11,265	11,716	12,185	12,672	13,179
Interest applied to negative balance ²	(2,483)	(2,375)	(2,526)	(2,640)	(2,640)
Capital Program Requirement (in 2013 dollars) ³	(8,895)	(17,932)	(12,144)	(14,967)	(5,715)
Impact of Inflation on Capital Program	-	(789)	(1,093)	(2,064)	(1,074)
Balance - End of Year	(34,848)	(44,228)	(47,806)	(54,805)	(51,055)

Note

- The projected Servicing Agreement Fees incorporate the approved rates for 2012, and increases in future years for inflation. The capital program requirements also incorporate projected increases due to inflation.*
- If the Servicing Agreement Fee Reserve is in a negative position, interest is calculated at the rate paid by the City for any debt required to fund the negative balance.*
- The Capital Program Requirement reflects an estimated inflation rate applied to capital requirements. The 2013 – 2017 Utility Capital Program is presented in current dollars (without inflation). The Utility model incorporates projected increases in revenues and expenditures due to inflation. The net operating surplus reflects future projected increases and as such, the inflationary projection for capital program requirements is also used in this table.*

A review of the SAF Policy in 2007 identified the option to design and build some infrastructure projects through funding arrangements with developers rather than through city borrowed funding. For that reason, developers have entered into front ending servicing agreements with the City and have constructed work that would normally be funded through the SAF reserve funds. Through these agreements, the developers are entitled to an offset in the form of servicing agreement fee credits that would otherwise be payable. The servicing agreement fee credit concept allows the development community to proceed with new subdivisions without waiting for the City to construct the infrastructure to support the development. The remaining SAF Credit Balance as of November 30, 2012 is just over \$893 thousand. It is anticipated that all outstanding credits will be redeemed in 2013.

Debt Financing

Section 135 of *The Cities Act* creates the authority to issue debt to finance capital projects. While debt is a source of capital financing, ultimately the cost of the debt (principal and interest) has to be funded through the utility operating budget. The following table is a summary of the outstanding debt and the debt maturing each year.

Current Debt Outstanding (Issued in 2011 and prior years)

The following table is a summary of the current outstanding debt, showing the year of issue and the debt maturing each year.

Schedule of Utility Debt Maturities (\$000's)					
Year	Debt Issues			Total	Per Cent of Total (%)
	\$6 Million May 2004	\$16 Million June 2009	\$43.1 Million June 2009 (GTH)		
2013	600	906	-	1,506	2.6
2014	600	906	43,100	44,606 ¹	77.5
2015	-	906	-	906	1.6
2016	-	906	-	906	1.6
2017	-	906	-	906	1.6
2018	-	906	-	906	1.6
2019	-	7,846	-	7,846	13.6
Total	1,200	13,282	43,100	57,582	100.0

Note:

1. The debt reassigned from the GTH is fully due in 2014. In that year, additional debt in the amount of \$43.1 million will be required to replace the reassigned GTH debt.

Committed Debt (Approved in 2012, Unissued)

In 2012, approval was given to issue \$23.0 million in debt. Because of delays in capital investment, issuing of this debt has also been delayed. This approved debt is expected to be issued in mid-2013.

Planned Future Debt Requirements

In addition to the debt already approved, the 2013 to 2016 Utility Capital Program is expected to require the following debt:

- \$52.0 million in 2014 (includes \$43.1 required to replace GTH debt).
- \$46.0 million in 2015
- \$51.0 million in 2016.

The Utility Model includes funding for debt issuance costs and the repayment of projected debt issues based on a thirty year term and an interest rate of 3.8% for 2013, 4% for 2014, 4.2% for 2015, and 4.4% for 2016. In 2014, the GTH debt will mature and new debt of \$43.1 million will be required to replace it.

The future debt requirements are subject to change, as capital requirements in future years may change, the projected cost of requirements could change, or revenues generated from rate increases may change. In addition to the projected debt required to fund the 2013 – 2017 Utility Capital Program, based on current revenue and expenditure projections in the Utility model, there are additional debt requirements beyond 2017. The following graph shows projected utility debt levels incorporating the existing debt and the projected additional debt for 2013 through 2017.

Utility Debt Projections

