

2007 BUDGET

Water and Sewer Utility Budget

- As Approved by City Council -

Table of Contents

Letter of Transmittal

Introduction.....	1
-------------------	---

Financial Information.....	7
----------------------------	---

Utility Services

Water.....	25
------------	----

Wastewater.....	39
-----------------	----

Drainage.....	47
---------------	----

Engineering and Operations Administration.....	55
--	----

Customer Billing and Collection.....	57
--------------------------------------	----

Debt Costs.....	61
-----------------	----

Utility Capital Program

Capital Program Summary.....	63
------------------------------	----

Water Supply, Pumping and Distribution.....	65
---	----

Wastewater Collection and Treatment.....	68
--	----

Drainage.....	72
---------------	----

Utility Capital Funding.....	74
------------------------------	----

Office of the City Manager
April 17, 2007

To: His Worship the Mayor,
and Members of City Council

Re: Water and Sewer Utility Budget

Each year City Council is required to adopt an operating and capital budget. There are three components to the budgets, the General Operating Budget, the Water and Sewer Utility Operating and Capital Budget and the General Capital Program. This document is the Water and Sewer Utility Budget, including the 2007 Utility Operating Budget and the 2007 – 2011 Utility Capital Program, as approved by City Council at its meeting on April 17, 2007.

Budget Highlights

- Utility rates for 2007 were previously approved by City Council in 2004, when rates were adopted for 2005 through 2007. For an average residential customer, the 2007 rates result in a 4.2% increase or about \$3.01 per month. The increase for a sample commercial customer is 4% or about \$18.35 per month.
- The rates previously approved for 2007 will result in increased revenues of about 4.1%. Details on the rates for 2006 and 2007 are provided on pages 16 through 18 of this document.
- The 2007 Utility Operating Budget provides the funding necessary to meet Council's service objectives for water, wastewater and drainage. The total 2007 operating budget for the utility, including debt repayment, is about \$43.5 million, an increase of \$421,200 from the 2006 budget. Operating costs, excluding debt repayment and interest, have increased by about \$1.7 million or about 5.6%. The major reason for the increase is the estimated salary increases for 2007, although there are a number of new initiatives offset by expenditure reductions. The increase is partially offset by a reduction in debt repayment costs.
- The 2007 – 2011 utility capital program totals \$198 million. In comparison, the total 2006 – 2010 utility capital program was about \$164.7 million.
- The 2007 – 2011 Capital Program proposes a total of \$100 million in debt financing to meet the increased capital requirements - \$35 million in 2009, \$15 million in 2010 and \$50 million in 2010.

Public Reporting

In 2005, the Province adopted new regulations in Part V.1 of *The Cities Regulations* regarding Public Reporting on Municipal Waterworks. The regulations apply only to waterworks, however since the utility includes water, wastewater and drainage services, the information required by the regulations is provided for the entire utility. The information requirements include:

- Information on the rate policy and capital investment strategy as adopted pursuant to sections 22.3 and 22.4 of the regulations. The information required with respect to the City's rate policy is provided on pages 13 through 16 of this document. Information on the capital investment strategy is included in the Utility Capital Program Section of this document and in particular, the Infrastructure Overview Section starting on page 59.
- A financial overview providing the information outlined in the regulations. The data outlined in the regulations is included in the Financial Information Section of this document on pages 8 through 10. The regulations also require a comparison of the utility revenues to expenditures and debt payments, expressed as a ratio in accordance with the following formula:

$$\frac{\text{Revenues}}{\text{(Expenditures + Debt Payments)}}$$

For 2007, based on the definitions in the regulations, the ratio for the Water and Sewer Utility is 1.36, based on revenues of \$59,026,400, expenditures of \$34,602,600 and debt repayments of \$8,900,000. In accordance with the definition in the regulations, expenditures include the interest cost on the debt, while debt payments are the principal repayments on the debt.

For 2007, the ratio indicates that revenues exceed expenditures and debt repayments by about 32%. By policy, the net revenue or surplus is used to fund transfers to the General Operating and General Capital budgets, with the balance used to fund future utility capital requirements. The ratio is projected to increase over the next five years as additional funding is generated to pay for the expansion to the wastewater treatment plant.

- Information on the current reserves and deferred revenue, capital plans for infrastructure projects and the sources of funding for the capital projects are detailed in the Utility Capital Program Section of this document starting on page 63.

Capital Requirements and Funding

Regina's location, in a sensitive natural environment far from a major water source impacts on the standards and costs for water supply and wastewater treatment and disposal. Additional information on the regional setting and the implications for Regina is provided in the Introduction Section of this document.

Federal and Provincial standards have been strengthened in recent years due in part to public concerns resulting from water quality problems in other communities. Regina has been and will continue to be a leader in ensuring that utility operations adhere to standards and respect the environment. Regina's operators have met the certification requirements set

out in regulations pursuant to *The Environmental Management and Protection Act*. A continued commitment to training, reporting and monitoring is required.

The 2007 – 2011 utility capital program totals \$192 million. Capital projections for the years 2007 through 2011 have increased from about \$164.7 million (in the 2006 utility model) to \$192 million, an increase of 20%.

The details of projected capital requirements and the estimated cost of those requirements have a relatively high degree of uncertainty. As studies are completed and updated, it is likely that additional requirements will be identified and the timing of requirements will be advanced. In addition, as detailed designs for capital projects are developed, it is likely that cost estimates will increase. While the utility model includes projections for 20 years, it is highly likely that the projected capital requirements and the estimated costs of those requirements will be greater than the current projections.

During 2007, the Administration will bring forward a report regarding options for financing the additional costs. Factors to be considered by Council include the level of rate increases for 2008 and beyond, debt repayment terms, as well as the level of the transfer to general operating and general capital.

If capital spending is deferred there is increased risk that the City would not be able to meet the standards (including the legislated standards) set for the provision of water, wastewater and drainage services. Failure to meet the standards would have significant implications for the City and the community.

Maintenance of the water, wastewater and drainage systems is a duty of the City in the interest of public health and safety. Ageing infrastructure, regulatory standards and Regina's environmental and geographic location all contribute to increasing costs, which result in a requirement to increase rates. The City has a duty to be responsible stewards of these essential utilities to promote the health, well being and economic opportunity of the community.

Respectfully submitted,

A handwritten signature in black ink, appearing to read "G. Davies". The signature is fluid and cursive, with a large initial "G" and a long, sweeping underline.

Glen B. Davies
City Manager

Introduction

Service Overview

Annually the City of Regina conducts a public survey. The following table provides a comparison of the public's responses for water and sewer services since the inception of the survey. **The public's rating of water and sewer services has increased since 1995.** The high rating is significant given the increased scrutiny over the last decade toward the provision of water and sewer services.

Rating of Water and Sewer Services

<u>Year</u>	<u>Very or Somewhat Satisfied</u>	<u>Very or Somewhat Dissatisfied</u>
2006	91%	9%
2005 ^(see note)	91%	9%
2004	89%	8%
2003	86%	13%
2002	88%	11%
2001	83%	15%
2000	81%	17%
1999	83%	15%
1998	81%	17%

Note – The 2005 survey was conducted using different response options as compared to the prior surveys. Services were ranked on a scale of 1 (Very Dissatisfied) to 5 (Very Satisfied). In the table, those ranking the service 3, 4 or 5 are included in the Very or Somewhat Satisfied group.

The Water and Sewer Utility provides water, wastewater and drainage services primarily to customers in Regina. The services provided through the utility include:

- **Water Supply, Pumping and Distribution**

The water system provides water for residential, institutional, commercial and industrial customers as well as water for fire protection. The system serves a population of over 190,000 including some customers outside the city limits. Service goals include:

- Providing water that meets or exceeds Provincial water quality standards and objectives.
- Providing water at adequate pressure and in sufficient quantity to satisfy the requirements for domestic and commercial use, irrigation and fire protection.
- Identifying and implementing improvements to the water system through long range planning, monitoring, improved operation, capital works and new technology.

- **Wastewater Collection and Treatment**

The wastewater system collects wastewater from all residential, institutional, commercial and industrial customers in the city. Wastewater treatment and final effluent meets Provincial environmental standards. Service goals include:

- Collecting domestic, commercial and industrial wastewater in the city and delivering it to wastewater treatment facilities.
- Producing a treated wastewater effluent that is biologically and physically safe for the environment and meets the requirements of the Provincially issued operating permit.
- Ensuring solids removed from the wastewater are treated and disposed of in an environmentally responsible manner.

- **Drainage**

The drainage system controls water runoff resulting from rainfall and melting snow in and around the city. The system serves approximately 60,000 residential, institutional, commercial and industrial properties. Service goals include:

- Operating and maintaining the drainage system to control run off water within the city to minimize inconvenience, property damage and danger to the public.
- Monitoring the potential for flood conditions in Wascana Creek and the storm channels and carrying out flood control measures as required.

Regional Setting

Regina's location, in a sensitive natural environment far from a major water source, is unique among the major Canadian cities. Regina's location impacts on the standards and costs for water supply and wastewater treatment and disposal. The map on the next page provides an overview of the regional setting.

Regina's water supply originates with snow melt and rainfall in the eastern Rocky Mountains that feed the tributaries of the South Saskatchewan River. The Gardiner and Qu'Appelle dams impound the South Saskatchewan River to form Diefenbaker Lake from which water is released into the Qu'Appelle River. The Qu'Appelle flows through Buffalo Pound Lake, the source of Regina and Moose Jaw's treated water supply. Buffalo Pound Lake is also the water source for large industrial users including the SaskFerro fertilizer plant and the Mosaic potash mine at Belle Plaine.

From Buffalo Pound Lake the Qu'Appelle flows eastwards through the Fishing Lakes on its way to joining the Assiniboine in the east of the province. Saskatchewan Watershed Authority manages water releases from Lake Diefenbaker to support a variety of uses in the Qu'Appelle valley besides water supply. Releases maintain lake levels for recreation use and provide water for agricultural irrigation. The Watershed Authority also operates dams and control structures maintaining water levels when flows are low and controlling flooding when flows are high.

Wascana Creek is a seasonal stream that originates to the east of Regina and flows through the city to join the Qu'Appelle downstream of Lumsden. Regina's storm water run off and treated wastewater flow into Wascana Creek. For much of the year these sources are the only water that feeds Wascana Creek, and without these sources, the Creek would be dry.

The nature of the Qu'Appelle system is influenced by both its natural setting and its many uses. Abundant sunshine and naturally occurring nutrients result in a highly productive biological system typical of prairie water bodies. Human activities (agriculture and development) create their own demands and influence the system.

Regina and Region

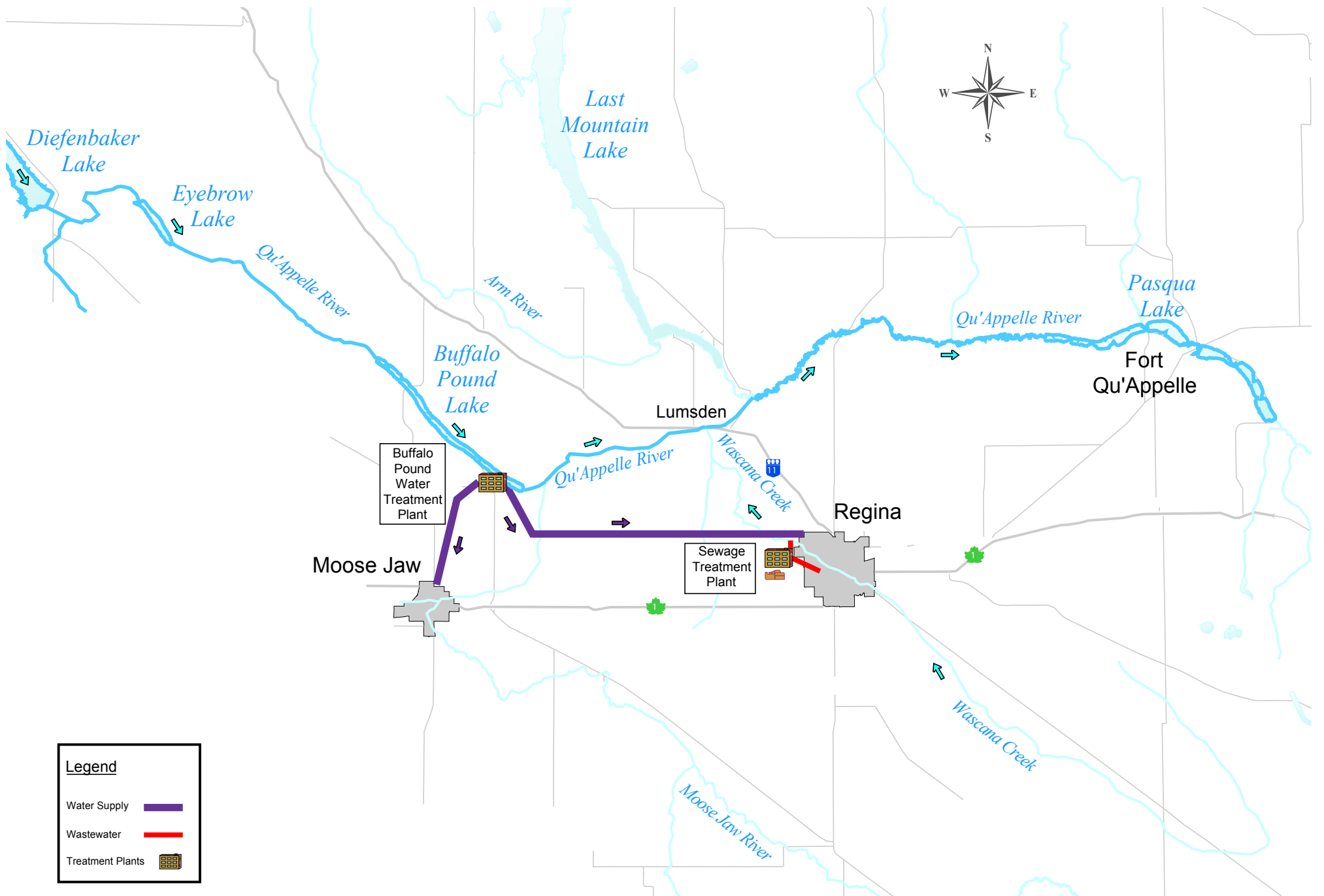

The City is a subscribing member and supporter of Partners for the Saskatchewan River Basin, an organization dedicated to public education and participation to preserve and protect the natural environment of the Saskatchewan River Basin.

Regina is the centre of an economic region comprised of approximately 40 communities. Initiatives are underway to strengthen partnerships and to collaborate on mutual opportunities and interests. Regina's utility systems already provide the basis for regional services and over time their role will increase.

Regina water supply and wastewater treatment systems are adapted to provide treatment that is appropriate to its natural setting and to minimize the city's influence on the receiving environment.

Regulatory Environment

Saskatchewan's Department of the Environment regulates water supply and distribution, and wastewater collection, treatment and disposal. Permits for the construction and operation of water and wastewater systems require specific standards to protect human health and to minimize impacts on the natural environment. A system of routine testing, inspections and annual reports ensures compliance.

Saskatchewan Watershed Authority is responsible for management of Saskatchewan's surface water and ground water resources. The Authority regulates the allocation of water, establishes management plans for the province's river basins and is responsible for land drainage and wetland preservation and enhancement. In 2004, the Authority initiated a consultative process to develop a plan for the Upper Qu'Appelle. City staff and Buffalo Pound Water Administration Board staff are actively involved in the planning process. The process is expected to take several years to complete.

In 2002, the Province responded to public concerns highlighted by the North Battleford cryptosporidium outbreak and subsequent inquiry by passing new regulations pursuant to *The Environmental Management and Protection Act*. This Act with its regulations introduced a range of measures to ensure consistent water quality and appropriate environmental protection throughout Saskatchewan. The requirements include mandatory operator certification, routine facility inspections, testing and reporting. System operators were required to provide a Water Quality Control Policy before December 31, 2003 and undertake a waterworks system assessment by December 31, 2005. **Regina has met both requirements.**

The mandatory certification program requires that certified operators are in charge of all key water supply and distribution, and wastewater collection and treatment operations. The level of certification depends on the size and complexity of the system, level one being the simplest and smallest systems, level four the largest and most complex. Regina's systems are designated as level four systems. The program provided a transition period to allow operators to achieve the required certification before July 15, 2005. Regina's operators meet the certification requirements.

In 2005, the Province adopted regulations that require municipalities to establish and publicly report on pricing and capital investment policies for their waterworks by July 1, 2006. **This budget document provides the information required by the new regulations.**

In 1999, the Federal Government enacted *The Canadian Environmental Protection Act*, (CEPA). This Act together with *The Fisheries Act* provides authority to regulate municipal waste water effluents and control discharges to receiving waters. CEPA regulations require municipalities to address any substances deemed to be "toxic" under CEPA. At present only two substances, ammonia and chlorination by-products have been designated "toxic". Ammonia is present in Regina's wastewater but there is a list of several hundred substances that could be so designated. Municipalities and Provincial regulators have been very concerned that Federal regulation with inflexible broadly based national standards could replace the current site-specific regulatory regime. The Federal Government has issued a Guideline for

addressing ammonia. It is expected the Federal Government will issue a regulation and timelines for addressing ammonia in wastewater discharges under *The Fisheries Act* in 2007.

The Canadian Council of Ministers of the Environment (CCME) is working on a national strategy to deal with Municipal Waste Water Effluents. The CCME recommendations are scheduled to be completed by mid 2007. Implementation schedules will be completed on a case by case municipality basis following adoption of the recommendations by the Federal Government in a regulation under *The Fisheries Act*. This CCME initiative, which has the support of the Federal Government, addresses the need to maintain a national approach to pollution prevention and environmental protection while recognizing local conditions and requirements. The CCME initiative may result in a more pragmatic approach to timing and implementing municipal wastewater effluent improvements than the initial CEPA Pollution Prevention Plan approach.

Receiving environment impacts are a key consideration for municipal wastewater effluent standards. City staff and Saskatchewan Environment have discussed, and are in broad agreement, on the principle that treated effluent standards for the City's upgraded wastewater treatment plant should reflect and be determined by environmental effects in the Qu'Appelle system. To address this principle, the City will undertake a significant monitoring program to document current conditions and help project future conditions in the Qu'Appelle system.

Regina's practice has been to provide water and wastewater treatment that meets all regulatory requirements, anticipates potential higher standards and, where practical, meets the higher requirement. Costs of regulatory compliance, such as the costs of training, certification, documentation and reporting will be higher than in the past. As well, there will be significantly higher capital expenditures required to meet the standards.

Financial Information

Customer Impact of Utility Rates

The 2005 – 2007 water, wastewater and drainage rates were approved by City Council (Bylaw 2004-35) in 2004. Examples of the impact of the 2007 rates are provided below.

Average Home Owner

The following chart illustrates the impact of the 2007 rates on a home owner who uses 360 cubic metres of water per year. The water consumption is typical for a family of two adults and two children, in a home with two bathrooms, a dishwasher and washing machine, on a lot with typical landscaping for Regina. **The cost increase resulting from the 2006 rates is about \$3.01 per month for the average homeowner.**

2007 Rate Impact - Average Home Owner

	2006	2007	Dollar Change	Per Cent Change
Water				
Basic Charge	\$ 129.00	\$ 135.05	\$ 6.05	
Volume Charge	306.00	316.80	10.80	
Total Water	435.00	451.85	16.85	3.9
Wastewater				
Basic Charge	99.00	102.20	3.20	
Volume Charge	221.40	230.26	8.86	
Total Wastewater	320.40	332.46	12.06	3.8
Drainage Infrastructure Levy	84.00	91.25	7.25	8.6
Total Annual Utility Charges	\$ 839.40	\$ 875.56	\$ 36.16	4.3

Sample Commercial Customer

The following chart illustrates the impact of the 2007 rates on a commercial customer with a 40 mm meter that uses 3,000 cubic metres of water per year, with a property size in the range of 3,001 to 5,000 m². This water consumption would be typical for a strip-mall with a restaurant and a hair salon with a parking lot and minimal landscaping.

2007 Rate Impact - Sample Commercial Customer

	2006	2007	Dollar Change	Per Cent Change
Water				
Basic Charge	\$ 232.20	\$ 240.90	\$ 8.70	
Volume Charge	2,550.00	2,640.00	90.00	
Total Water	2,782.20	2,880.90	98.70	3.5
Wastewater				
Basic Charge	178.20	189.80	11.60	
Volume Charge	2,205.00	2,293.20	88.20	
Total Wastewater	2,383.20	2,483.00	99.80	4.2
Drainage Infrastructure Levy	336.00	357.70	21.70	6.5
Total Annual Utility Charges	\$ 5,501.40	\$ 5,721.60	\$ 220.20	4.0

Utility Operating Budget Summary

Details (\$000's)	2006 Budget	2006 Actual	2007 Budget	Change 2006 to 2007	
				Dollar Change	Per Cent Change
Operating Revenue:					
Water	29,053.6	30,542.8	30,078.6	1,025.0	3.5
Wastewater	21,143.4	21,482.7	21,988.6	845.2	4.0
Drainage	6,037.3	6,109.3	6,546.4	509.1	8.4
Other	490.3	356.6	412.8	(77.5)	(15.8)
Total Operating Revenue	<u>56,724.6</u>	<u>58,491.4</u>	<u>59,026.4</u>	<u>2,301.8</u>	<u>4.1</u>
Operating Expenditures:					
Water	12,996.3	12,628.0	13,301.1	304.8	2.3
Wastewater	6,663.9	6,437.0	6,652.1	(11.8)	(0.2)
Drainage	1,280.9	861.4	1,157.4	(123.5)	(9.6)
Engineering and Operations	6,001.4	6,311.1	6,496.1	494.7	8.2
Utility Administration	5,127.2	5,055.1	5,457.1	329.9	6.4
Debt Costs	11,011.7	10,906.7	10,438.8	(572.9)	(5.2)
Total Operating Expenditures	<u>43,081.4</u>	<u>42,199.3</u>	<u>43,502.6</u>	<u>421.2</u>	<u>1.0</u>
Utility Operating Surplus	<u>13,643.2</u>	<u>16,292.1</u>	<u>15,523.8</u>	<u>1,880.6</u>	<u>13.8</u>
Distribution of Surplus:					
Transfer to General Operating	4,672.0	4,672.0	4,852.2	180.2	3.9
Transfer to General Capital:					
MRIF Funding	1,700.0	1,700.0	1,700.0	-	-
Transfer to General Utility Reserve	7,271.2	9,920.1	8,971.6	1,700.4	23.4
Total Surplus	<u>13,643.2</u>	<u>16,292.1</u>	<u>15,523.8</u>	<u>1,880.6</u>	<u>13.8</u>

Utility Capital Program Summary

	2007	2008	2009	2010	2011	Total
Capital Expenditures						
Water Supply, Pumping & Distribution	3,580	4,890	4,640	5,640	11,290	30,040
Wastewater Collection & Treatment	7,420	14,190	42,835	21,455	54,145	140,045
Drainage	4,470	3,455	4,860	5,450	3,800	22,035
Total Expenditures	<u>15,470</u>	<u>22,535</u>	<u>52,335</u>	<u>32,545</u>	<u>69,235</u>	<u>192,120</u>
Capital Funding						
General Utility Reserve	12,954	19,151	13,896	14,474	12,529	73,004
Debt	-	-	35,000	15,000	50,000	100,000
Municipal Rural Infrastructure Fund	1,700	1,700	1,700	1,700	1,700	8,500
Utility Development Charges	816	1,600	1,459	1,133	2,710	7,718
Other External Contributions	-	84	280	238	2,296	2,898
Total Funding	<u>15,470</u>	<u>22,535</u>	<u>52,335</u>	<u>32,545</u>	<u>69,235</u>	<u>192,120</u>

Utility Operating Revenues

Revenue Details (\$000's)	2006 Budget	2006 Actual	2007 Budget	Change 2006 to 2007	
				Dollar Change	Per Cent Change
Water Revenue					
Metered Water Charges	28,565.8	29,562.2	29,586.6	1,020.8	3.6
Unmetered Water Charges	208.6	174.2	208.6	-	-
Other Water Service Charges	279.2	806.4	283.4	4.2	1.5
Subtotal	29,053.6	30,542.8	30,078.6	1,025.0	3.5
Wastewater Revenue					
Wastewater Charges	21,093.4	21,434.2	21,938.6	845.2	4.0
Wastewater Service Surcharges	50.0	48.5	50.0	-	-
Subtotal	21,143.4	21,482.7	21,988.6	845.2	4.0
Drainage Revenue					
Drainage Infrastructure Levy	6,037.3	6,109.3	6,546.4	509.1	8.4
Other Revenue					
Local Improvement Levy	82.3	29.2	-	(82.3)	(100.0)
Late Payment & Transfer Charges	321.5	301.9	326.3	4.8	1.5
Claims Revenue	42.0	10.7	42.0	-	-
Other Revenues	44.5	14.8	44.5	-	-
Subtotal	490.3	356.6	412.8	(77.5)	(15.8)
Total Utility Revenue	56,724.6	58,491.4	59,026.4	2,301.8	4.1

Use of 2007 Utility Revenue

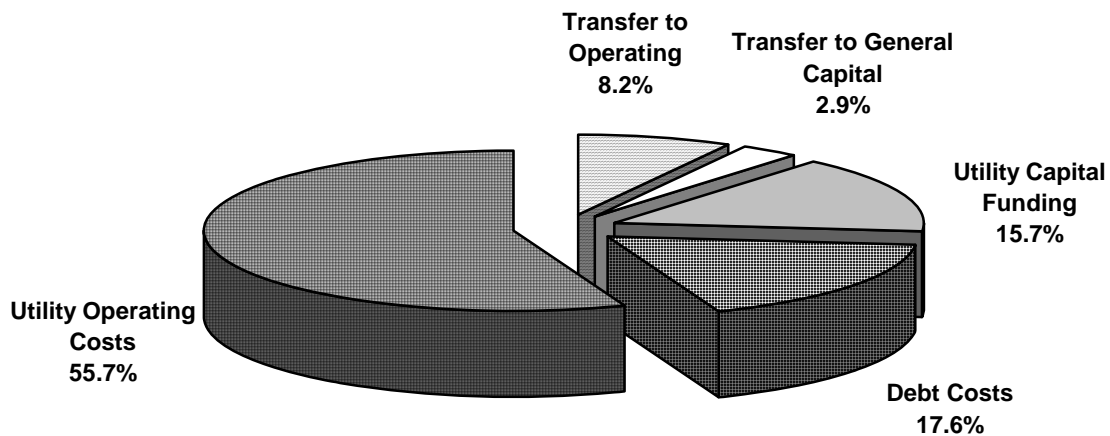

Utility Operating Expenditures

Expenditure Details (\$000's)	2006 Budget	2006 Actual	2007 Budget	Change 2006 to 2007	
				Dollar Change	Per Cent Change
Water					
Water Supply	5,624.7	5,552.0	5,852.3	227.6	4.0
Water Pumping	1,102.3	978.6	1,101.1	(1.2)	(0.1)
Water Distribution	6,269.3	6,097.4	6,347.7	78.4	1.3
Subtotal	<u>12,996.3</u>	<u>12,628.0</u>	<u>13,301.1</u>	<u>304.8</u>	<u>2.3</u>
Wastewater					
Wastewater Collection	1,841.9	1,786.4	1,858.4	16.5	0.9
Wastewater Treatment	4,822.0	4,650.6	4,793.7	(28.3)	(0.6)
Subtotal	<u>6,663.9</u>	<u>6,437.0</u>	<u>6,652.1</u>	<u>(11.8)</u>	<u>(0.2)</u>
Drainage	<u>1,280.9</u>	<u>861.4</u>	<u>1,157.4</u>	<u>(123.5)</u>	<u>(9.6)</u>
Engineering and Operations					
General Administration	919.3	718.9	931.0	11.7	1.3
Water, Wastewater Collection and Drainage Engineering	1,088.1	1,113.9	1,449.4	361.3	33.2
Environmental Engineering	337.9	219.2	241.5	(96.4)	(28.5)
Development and Technical Services	771.3	1,212.9	800.0	28.7	3.7
Operations Administration	2,687.1	2,867.1	2,883.8	196.7	7.3
Facilities	197.7	179.2	190.4	(7.3)	(3.7)
Subtotal	<u>6,001.4</u>	<u>6,311.2</u>	<u>6,496.1</u>	<u>494.7</u>	<u>8.2</u>
Utility Administration					
Customer Service, Billing & Collection	2,411.1	2,339.0	2,620.9	209.8	8.7
Utility Administration Charge	2,716.1	2,716.1	2,836.2	120.1	4.4
Subtotal	<u>5,127.2</u>	<u>5,055.1</u>	<u>5,457.1</u>	<u>329.9</u>	<u>6.4</u>
Debt Costs	<u>11,011.7</u>	<u>10,906.7</u>	<u>10,438.8</u>	<u>(572.9)</u>	<u>(5.2)</u>
Total Utility Expenditures	<u><u>43,081.4</u></u>	<u><u>42,199.4</u></u>	<u><u>43,502.6</u></u>	<u><u>421.2</u></u>	<u><u>1.0</u></u>

Staffing Summary

FTE's by Department	2005	2006	2007
Corporate Services			
Permanent	3.0	3.0	3.0
Engineering and Works			
Permanent	153.8	160.5	165.1
Casual	31.6	32.5	32.7
Finance			
Permanent	22.0	22.0	23.0
Casual	2.8	2.3	1.3
Total	213.2	220.3	225.1

Analysis of Operating Budget Change

Details of Operating Budget Changes	(\$000's)
2006 Budget	43,081.4
1. Salaries and Benefits - Includes cost changes resulting from merit increases, classification reviews, employer benefit costs.	162.7
2. Estimated general salary increases for 2007.	416.6
3. Delete 2006 specials, which included: Lift Station Upgrades (25.0), Alum Enhancer (50.0), Lab Safety Assessment (40.0), Asset Management (60.0), Wascana Creek Receiving Environment Study (110.0), Meter Re-sequencing (50.0) and CIS System Upgrade (49.0).	(384.0)
4. Decrease in PST of 2%.	(98.7)
5. Decrease in Fleet and Garage charges.	(227.0)
6. Increase in Allowance for Uncollectible Accounts - Overall allowances are 0.5% of revenue. Increase in revenue requires a corresponding increase in the allowance.	30.0
7. Increase in the cost of water from Buffalo Pound Water Treatment Plant.	132.0
8. Decrease in electrical costs due to usage at the Buffalo Pound Water Treatment Plant resulting from installation of more efficient pumps.	(69.4)
9. Increase in Cost of Liquid Alum - Liquid Alum (aluminum sulphate) is utilized on a continuous basis in the treatment of wastewater. This product is externally produced and supplied under a competitively bid multi-year supply contract which allows for annual pricing adjustments based on market pricing of constituent products and transportation and based on the Consumer Price Index. The proposed 2007 budget accounts for a 7.2% increase which occurred in 2006 and an anticipated mid 2007 increase.	50.0
10. Increase in Cost of Polymer - Polymer is utilized in conjunction with aluminium sulphate in the final stages of wastewater treatment to remove solids, nutrients and bacteria. Nominal pricing increases and recent year expenditures over the current budget allocation require a budgeted increase for 2007.	20.0
11. Increased Laboratory Chemical Costs and Testing Requirements - The Wastewater Treatment Facility Laboratory provides wet chemistry testing services to support wastewater treatment performance and compliance requirements. Support is also provided to City of Regina sections such as Environmental Engineering.	12.0
12. Increased Cost of Contracted Laboratory Services - The Wastewater Treatment Facility Laboratory provides daily, weekly, monthly and yearly testing services to support wastewater treatment and various City of Regina environmental needs. A portion of the testing requirements are contracted out to external laboratories due to the specialized nature or uniqueness of the work and testing equipment required. Also, external testing of duplicate samples is routinely performed for quality assurance purposes.	15.0
13. Water Meter Program - During the water meter/AMR update project, the annual operating budget for the water meter program was reduced. Replacement residential meters and meters for new residential installations were funded through the capital project. The meter replacement capital project has now ended requiring reinstatement of the operating budget for water meter equipment.	240.0

Details of Operating Budget Changes		(\$000's)
14. Environmental Engineering one-time Contracted Services.		(10.0)
15. Digital Plans in Field - The implementation of digital infrastructure records for operational use in the field has reduced the need for the production of hardcopy infrastructure maps.		(8.0)
16. Secondary Lagoon Maintenance - Improvement from a previous lagoon refurbishment and operational experience has resulted in lower maintenance demand.		(59.8)
17. Water Conservation - This represents a reallocation in advertising and communications.		(17.0)
18. Hydrant Maintenance Program - This one-time reallocation is due to the transition in the workforce and staff shortages, as well as proposed asset management review. The asset management program review will determine appropriate hydrant maintenance levels.		(150.0)
19. Domestic Sewer Cleaning - This one-time reallocation is proposed due to equipment delivery and availability delays.		(100.0)
20. After Hour Water Repairs - This represents a reduction in cost of repairs through improved operational efficiencies such as overtime control and work process improvements.		(50.0)
21. Valve Maintenance Program - This represents a slight decrease in current planned valve asset management. The asset management program review will determine appropriate valve maintenance levels.		(25.0)
22. Underground Asset Management - This item is to establish new permanent positions to address long term asset management needs. Sewer, water and drainage linear systems are in poor condition and continue to deteriorate. These new resources are required to analyze, plan and implement programs for system rehabilitation and renewal. This initiative by the City Administration is required to properly manage new large capital projects and operations/maintenance programs to sustain necessary water, sewer and drainage services to the community (increase 3.0 permanent FTE's).		160.4
23. Asset Management (One Time Investment) - Funding for a partnership with the City of Saskatoon to develop an Asset Management framework for buried utilities.		45.0
24. Capital Improvement Project Inspections - There has been an increase in the level of work activities provided by other utilities and contractors for capital improvement projects. An increase in budget funds is required to provide for engineering inspections to match this. This will result in an increase of casual FTE's from 1.7 to 2.0, for a net increase of .3 casual FTE's.		11.7
25. Wastewater Trunk System - Capacity and condition problems have been identified with the current trunk sewer system through the Waste Water System Assessment. Engineering services are required to clearly detail problem areas and determine short term solutions and a long term strategy for the delivery of wastewater from the collection system to the treatment plants. Total project costs \$400,000 with \$250,000 allocated in 2007 and \$150,000 in 2008.		250.0
26. Infrastructure Planning (Long Term Investment). This will provide technical expertise and support various programs administered by the Division related to protection and monitoring of infrastructure assets and infrastructure construction (increase 0.4 permanent FTE's).		12.9
27. Lab Safety Assessment (One Time Investment) - Funding for an external health and safety audit of the Wastewater Treatment Plant Laboratory procedures to mitigate safety risks for staff. This item was approved in 2006, but wasn't done because the construction of the new lab facilities was not complete.		42.0
28. Policy and Procedure Analyst (Long Term Investment) - Funding for one new Policy and Procedure Analyst. This position is required for the successful implementation and administration of the revised Development Charge policy underway in 2007. The position would subsequently provide capacity to administer policy and revenue generation opportunities related to municipal infrastructure and Rights of Way. 60% of this position is to be funded through the General Operating Budget (increase 0.4 permanent FTE's).		14.5
29. Training and Development (Long Term Investment) - This represents an increase in funding to allow for ongoing training for current and new staff. The training proposed will allow staff to maintain appropriate knowledge and skill levels as technology and methodologies change.		6.9
30. Asbestos Cement Watermain Management Strategy - This provides funding for the development of a management strategy for repairing and replacing asbestos cement (AC) watermains. This work is being done by Vemax Consulting and the City of Regina and is a continuation of work that was started but not completed in 2006. The strategy will result in an effective use of both operating and capital budgets in future years for managing the 535 km of AC watermains in the city.		60.0
31. Return to Work and Safety Award Program - This provides funding for training employees requiring accommodation and for a recognition program for performance in the area of safety.		40.0

Details of Operating Budget Changes		(\$000's)
32. Wastewater Systems Analysis - The Wastewater System is a major asset and additional resources are required to improve the management of it. This new position will provide systems engineering re: the wastewater trunk system, transfer of wastewater to treatment plant, reduction of inflow and infiltration and planning for system improvements (increase 1.0 permanent FTE's).	48.5	
33. Monthly Water Billing - Increase to cover additional costs resulting from billing monthly instead of bi-monthly. Includes \$180,000 for additional postage costs, \$73,800 for paper, envelopes and printing charges, and \$46,200 for one additional employee to manage the increased workload (increase 1.0 permanent FTE's).	300.0	
34. Debt costs - Reduction in debt costs due to the retirement of debt repaid In 2006.	(572.9)	
35. Administrative Charge - Increase in the administrative charge as per the policy. The charge is 5% of the prior years budgeted revenue.	120.1	
36. Total of all other changes.	2.7	
2007 Budget	<u>43,502.6</u>	

Utility Rates, Policies and Planning

The information provided in this section is intended to provide details of the utility rates and an overview of financial policies and planning for the Water and Sewer Utility. **The information is required in part to meet the requirements of Part V.1 of *The Cities Regulations* regarding Public Reporting on Municipal Waterworks.** The regulations apply only to waterworks, however, since the utility includes water, wastewater and drainage services, the information required by the regulations is provided for the entire utility. The regulations provide for certain policies to be adopted by bylaw or resolution. **The Water and Sewer Utility budget document is submitted to Committee and Council and the budget adopted by resolution. The resolution adopting the budget, which includes the policies in the budget document, meets the requirements of the regulations.**

Utility Rates and Rate Policies

Section 22.3 of *The Cities Regulations* requires Council to adopt a rate policy that sets out the rates or fees to be charged to consumers for the use of water. The policy must include the method used to determine those rates or fees. In establishing utility rates, the following policies have been adopted in the past by City Council:

1. Utility rates are to be established such that they are sufficient, based on long term projections, to fully fund utility operating costs, interest cost and debt repayments, capital requirements, and transfer policies, taking into account the operating and infrastructure requirements of the utility required to meet the service goals of the utility, as determined by City Council or prescribed by legislation. The objectives for the Utility's rate structure are:
 - **Financial Self Sufficiency** – Utility rates must generate revenue adequate to meet all operating and capital costs of the Utility in both the short and the long term.
 - **Conservation** – Utility rates should encourage customers to use water responsibly.
 - **Reduction of Peak Demand** – The Utility rates should encourage water conservation during summer months, reducing the need for infrastructure investment and higher rates.
 - **Equity** – The Utility rates should result in a charge to customers according to the cost of services they utilize.
2. The rate structure for water and wastewater will include a base fee that varies according to the size of the water meter. The variation in the base rate by meter size will be based on the schedule recommended by the American Water Works Association (AWWA). The ratios for the base rate based on meter size are shown in the following table.

Water and Wastewater Base Fee Ratios

<u>Meter Size</u>	<u>AWWA Standard Ratio</u>	<u>Meter Size</u>	<u>AWWA Standard Ratio</u>
15 mm	1.0	75 mm	11
18 mm	1.0	100 mm	14
25 mm	1.4	150 mm	21
40 mm	1.8	200 mm	29
50 mm	2.9		

3. The rate structure for water and wastewater will include a uniform rate for each cubic metre of water consumed and each cubic metre of deemed wastewater flow. For water, the uniform rate is applied to all consumption. For wastewater, the deemed volume is a percentage of the water consumption. The percentages are:
 - For residential customers, the wastewater volume is 82% of the water consumption;
 - For multiple unit residential properties, the percentage is 95% of the water consumption; and,
 - For institutional, commercial and industrial properties, the percentage is 98% of the water consumption.
4. The rate structure for the storm drainage infrastructure levy will be based on the size of the property, with larger properties paying a higher levy. The ratios approved by City Council in 2001 (CR01-189) are shown in the following table. The drainage levy applies irrespective of whether the property is connected to the water or wastewater systems.

Drainage Infrastructure Rate Ratios

Area of Property	Rate Ratio	Area of Property	Rate Ratio
0 to 1,000 m ²	1.0	17,001 to 19,000 m ²	18.0
1,001 to 3,000 m ²	2.0	19,001 to 21,000 m ²	20.0
3,001 to 5,000 m ²	4.0	21,001 to 23,000 m ²	22.0
5,001 to 7,000 m ²	6.0	23,001 to 25,000 m ²	24.0
7,001 to 9,000 m ²	8.0	25,001 to 27,000 m ²	26.0
9,001 to 11,000 m ²	10.0	27,001 to 29,000 m ²	28.0
11,001 to 13,000 m ²	12.0	29,001 to 31,000 m ²	30.0
13,001 to 15,000 m ²	14.0	Over 31,000 m ²	32.0
15,001 to 17,000 m ²	16.0		

5. **In the setting of rates, the utility must generate a surplus**, with the surplus intended for the following purposes:
 - **Transfer to the General Operating Fund** – For 2007, the transfer is the total of the following amounts:
 - 7.5% of the previous years budgeted revenues for billed water consumption, wastewater charges and drainage infrastructure levy; and,
 - An amount (\$675,000) estimated to be 3/7^{ths} of the GST rebate received by the Utility. This amount is the additional rebate provided by the Federal Government starting in 2004.
 - **Transfer to the General Capital Fund** – For 2007, the transfer is \$1,700,000, equal to the Municipal Rural Infrastructure Fund grants received by the Utility.
 - **Transfer to the General Utility Reserve** – The balance of the Utility’s surplus, after the transfer to the General Operating Fund and General Capital Fund, is transferred to the General Utility Reserve. The purpose of the reserve is to provide a source of financing for capital projects. In the event that the Utility incurs an operating deficit in a given year, the deficit would also be funded from the reserve.

City Council's practice has been to establish utility rates every three years, with a three-year schedule of rates adopted. In 2004 (Bylaw 2004-35), rates were set for the 2005 – 2007 period. **As a result of increasing capital requirements for the utility, it is anticipated that rate increases in the range of 10% per year will be required for 2008, 2009 and 2010. A full rate review, recommending a rate schedule for 2008 through 2010, will be provided in mid 2007.**

The previously approved utility rates for 2005 through 2007 are shown in the following tables. Please note, the 2005 and 2006 rates were billed every two months and were based on a fixed bi-monthly charge. Rates in 2007 are billed monthly and are based on a daily fixed charge.

Water Rates
(Billed Bi-Monthly)

	<u>Previously Approved</u>	
	2005	2006
Base Fee per Billing Period:		
15 mm/18 mm water meter	\$ 20.50	\$ 21.50
25 mm water meter	28.70	30.10
40 mm water meter	36.90	38.70
50 mm water meter	59.50	62.40
75 mm water meter	225.50	236.50
100 mm water meter	287.00	301.00
150 mm water meter	430.50	451.50
200 mm water meter	594.50	623.50
250 mm water meter	750.00	786.50
Volume Charge:		
Charge per Cubic Metre	\$ 0.83	\$ 0.85

Water Rates 2007
(Billed Monthly)

	<u>Previously Approved</u>	
	2007	
Daily Base Charge:		
15 mm/18 mm water meter	\$	0.37
25 mm water meter		0.37
40 mm water meter		0.52
50 mm water meter		0.67
75 mm water meter		1.07
100 mm water meter		4.07
150 mm water meter		5.18
200 mm water meter		7.77
250 mm water meter		10.73
Volume Charge:		
Charge per Cubic Metre	\$	0.88

Wastewater Rates

(Billed Bi-Monthly)

	Previously Approved	
	2005	2006
Base Fee per Billing Period:		
15 mm/18 mm water meter	\$ 15.50	\$ 16.50
25 mm water meter	21.70	23.10
40 mm water meter	27.90	29.70
50 mm water meter	45.00	47.90
75 mm water meter	170.50	181.50
100 mm water meter	217.00	231.00
150 mm water meter	325.50	346.50
200 mm water meter	449.50	478.50
250 mm water meter	567.00	603.50
Volume Charge:		
Charge per Cubic Metre	\$ 0.72	\$ 0.75

Wastewater Rates 2007

(Billed Monthly)

	Previously Approved	
	2007	
Daily Base Charge:		
15 mm/18 mm water meter	\$	0.28
25 mm water meter		0.28
40 mm water meter		0.40
50 mm water meter		0.52
75 mm water meter		0.84
100 mm water meter		3.17
150 mm water meter		4.03
200 mm water meter		6.04
250 mm water meter		8.34
Volume Charge:		
Charge per Cubic Metre	\$	0.78

Drainage Infrastructure Levy Rates

(Billed Every Two Months)

Area of Property	Previously Approved	
	2005	2006
0 to 1,000 m ²	\$ 13.00	\$ 14.00
1,001 to 3,000 m ²	26.00	28.00
3,001 to 5,000 m ²	52.00	56.00
5,001 to 7,000 m ²	78.00	84.00
7,001 to 9,000 m ²	104.00	112.00
9,001 to 11,000 m ²	130.00	140.00
11,001 to 13,000 m ²	156.00	168.00
13,001 to 15,000 m ²	182.00	196.00
15,001 to 17,000 m ²	208.00	224.00
17,001 to 19,000 m ²	234.00	252.00
19,001 to 21,000 m ²	260.00	280.00
21,001 to 23,000 m ²	286.00	308.00
23,001 to 25,000 m ²	312.00	336.00
25,001 to 27,000 m ²	338.00	364.00
27,001 to 29,000 m ²	364.00	392.00
29,001 to 31,000 m ²	390.00	420.00
Over 31,000 m ²	416.00	448.00

Drainage Infrastructure Levy Rates

(Billed Monthly)

Area of Property	Daily Base Charge	
	2007	
0 to 1,000 m ²	\$	0.25
1,001 to 3,000 m ²		0.49
3,001 to 5,000 m ²		0.99
5,001 to 7,000 m ²		1.48
7,001 to 9,000 m ²		1.97
9,001 to 11,000 m ²		2.47
11,001 to 13,000 m ²		2.96
13,001 to 15,000 m ²		3.45
15,001 to 17,000 m ²		3.95
17,001 to 19,000 m ²		4.44
19,001 to 21,000 m ²		4.93
21,001 to 23,000 m ²		5.43
23,001 to 25,000 m ²		5.92
25,001 to 27,000 m ²		6.41
27,001 to 29,000 m ²		6.90
29,001 to 31,000 m ²		7.40
Over 31,000 m ²		7.89

Utility Model

The purpose of the model is to project future operating revenues and expenditures along with capital requirements and capital funding. The major decisions in generating the projections for the Utility are:

- **Utility Rates** – While the objective is to minimize the need for rate increases, a parallel objective is to ensure required rate increases are gradual, rather than having large increases when major capital expenditures are required.
- **Capital Expenditures** – There are service goals for each component of the utility that determine the long term capital requirements. There is some flexibility in planning for capital expenditures. The utility model can be used to evaluate the financial implications of alternate schedules for capital expenditures.
- **Capital Funding** – Historically, capital funding has been provided through the issuing of debt or the use of internal reserves. The utility model can be used to evaluate the implications of the use of debt.

The utility model is based on the following assumptions:

- **Water Consumption** – The model uses an annual billable water consumption figure of almost 24 million cubic metres. The model is based on the current trend for water consumption and the assumption that total consumption will not change significantly in the future.
- **Operating Costs** – The model uses the 2007 operating budget and applies an inflation rate of 3% per year to forecast costs for the next 20 years. The cost of water supplied by the Buffalo Pound Water Treatment Plant is projected to increase at a rate of 5% per year. Actual costs will differ from the projected costs over time, but the assumptions are considered reasonable for the purpose of the model.
- **Utility Rates** – The utility rates approved for 2007 are used in the model. Revised rates are proposed for 2008 through 2010. **For the period 2008 through 2010, rate increases in the range of 10% each year are required.** Future rate increases are dependent primarily on the projected level of capital expenditures. Changes in future capital requirements will result in a change in future rate requirements.
- **Capital Expenditures** – The model accommodates the capital expenditures in the proposed 2007 – 2011 Utility Capital Program, along with future capital requirements based on a 20 year capital expenditure plan. The current version of the utility model has projected capital costs (based on current dollars) of about \$414.4 million from 2012 to 2026.
- **Capital Funding** – The model includes projections for capital funding from the General Utility Reserve and Utility Development Charges. Capital funding beyond that available from the reserve or development charges must be provided through external financing. **Capital financing requirements by debt issuance in the 2007 – 2011 Utility Capital program total \$100 million; \$35 million in 2009, \$15 million in 2010 and \$50 million in 2011. Additional debt financing is projected to be required beyond 2011.**

Utility Customers

The Water and Sewer Utility provides services to a population of over 190,000, including service to some customers and communities outside of the city limits. The following tables provide information on the number and categories of utility customers.

Water and Sewer Utility Customers

	<u>Water Customers</u>	<u>Wastewater Customers</u>	<u>Drainage Customers</u>
Residential	56,631	56,615	56,229
Multi-Unit Residential	801	798	742
Commercial	3,112	2,960	3,134
Summer Service	195	24	-
Total	<u>60,739</u>	<u>60,397</u>	<u>60,105</u>
Within City Limits	60,600	60,362	60,105
Outside City Limits	139	35	-
Total	<u>60,739</u>	<u>60,397</u>	<u>60,105</u>

Water Customers

<u>Size of Connection</u>	<u>Residential</u>	<u>Multi-Unit Residential</u>	<u>Commercial</u>	<u>Summer Service</u>	<u>Total</u>
15 mm - 5/8"	53,947	23	1,215	7	55,192
18 mm - 3/4"	2,570	226	1,078	22	3,896
25 mm - 1"	106	344	376	28	854
40 mm - 1.5"	8	105	145	42	300
50 mm - 2"	-	47	162	84	293
75 mm - 3"	-	56	114	8	178
100 mm - 4"	-	-	15	4	19
150 mm - 6"	-	-	5	-	5
200 mm - 8"	-	-	2	-	2
Total	<u>56,631</u>	<u>801</u>	<u>3,112</u>	<u>195</u>	<u>60,739</u>

Wastewater Customers

<u>Size of Connection</u>	<u>Residential</u>	<u>Multi-Unit Residential</u>	<u>Commercial</u>	<u>Summer Service</u>	<u>Total</u>
15 mm - 5/8"	53,945	23	1,181	3	55,152
18 mm - 3/4"	2,559	226	1,031	2	3,818
25 mm - 1"	104	344	358	4	810
40 mm - 1.5"	7	103	134	6	250
50 mm - 2"	-	47	129	7	183
75 mm - 3"	-	55	109	2	166
100 mm - 4"	-	-	11	-	11
150 mm - 6"	-	-	5	-	5
200 mm - 8"	-	-	2	-	2
Total	<u>56,615</u>	<u>798</u>	<u>2,960</u>	<u>24</u>	<u>60,397</u>

Drainage Customers

<u>Area of Property</u>	<u>Residential</u>	<u>Multi Residential</u>	<u>Commercial</u>	<u>Number of Properties</u>
0 to 1,000 m ²	56,168	356	1,315	57,839
1,001 to 3,000 m ²	-	306	815	1,121
3,001 to 5,000 m ²	-	41	316	357
5,001 to 7,000 m ²	1	28	164	193
7,001 to 9,000 m ²	-	11	109	120
9,001 to 11,000 m ²	-	11	75	86
11,001 to 13,000 m ²	1	8	56	65
13,001 to 15,000 m ²	-	4	50	54
15,001 to 17,000 m ²	-	1	42	43
17,001 to 19,000 m ²	-	3	25	28
19,001 to 21,000 m ²	-	5	30	35
21,001 to 23,000 m ²	-	2	17	19
23,001 to 25,000 m ²	-	1	13	14
25,001 to 27,000 m ²	-	1	9	10
27,001 to 29,000 m ²	-	-	13	13
29,001 to 31,000 m ²	-	-	6	6
Over 31,000 m ²	-	1	101	102
Total Properties	<u>56,170</u>	<u>779</u>	<u>3,156</u>	<u>60,105</u>

Utility Rate History and Comparisons

The following tables detail the history of utility rates since 1991 (1992 for the Drainage Infrastructure Levy), and the annual cost and annual cost increase for a sample residential customer with 360 cubic metres of water consumption a year.

Water Rate History

Year	Consumption in	Fixed Annual Charge	Volume	Cost for Sample Customer	
	Fixed Charge (Cubic Metres)		Charge (Per Cubic Metre)	Annual Charge (360 m ³)	Per Cent Increase
1991	28.3	93.42	0.565	200.80	5.1%
1992	28.3	98.40	0.593	211.20	5.2%
1993	28.3	106.20	0.643	228.48	8.2%
1994	28.3	115.20	0.693	247.02	8.1%
1995	28.3	121.20	0.728	259.68	5.1%
1996	25.0	125.10	0.740	280.50	8.0%
1997	22.0	131.40	0.750	302.40	7.8%
1998	19.0	138.00	0.750	322.50	6.6%
1999	16.0	138.00	0.750	336.00	4.2%
2000	13.0	138.00	0.750	349.50	4.0%
2001	10.0	138.00	0.750	363.00	3.9%
2002	none	105.00	0.770	382.20	5.3%
2003	none	109.50	0.790	393.90	3.1%
2004	none	117.00	0.810	408.60	3.7%
2005	none	123.00	0.830	421.80	3.2%
2006	none	129.00	0.850	435.00	3.1%
2007	none	135.05	0.880	451.85	3.9%

Wastewater Rate History

Year	Consumption in	Fixed Charge	Volume	Cost for Sample Customer	
	Fixed Charge (Cubic Metres)		Charge (Per Cubic Metre)	Annual Charge (360 m ³)	Per Cent Increase
1991	28.3	87.48	0.558	149.10	5.0%
1992	28.3	94.80	0.601	169.44	13.6%
1993	28.3	102.60	0.650	183.36	8.2%
1994	28.3	111.00	0.700	197.94	8.0%
1995	28.3	114.60	0.721	204.18	3.2%
1996	25.0	105.00	0.690	204.36	0.1%
1997	22.0	105.90	0.660	212.82	4.1%
1998	19.0	106.50	0.630	219.90	3.3%
1999	16.0	106.50	0.630	231.24	5.2%
2000	13.0	106.50	0.630	242.58	4.9%
2001	10.0	106.50	0.630	253.92	4.7%
2002	none	76.50	0.650	268.38	5.7%
2003	none	81.00	0.670	278.78	3.9%
2004	none	87.00	0.690	290.69	4.3%
2005	none	93.00	0.720	305.54	5.1%
2006	none	99.00	0.750	320.40	4.9%
2007	none	102.20	0.780	332.46	3.8%

Drainage Infrastructure Levy Rate History

Year	Property Category	Annual Levy	Percentage Increase
1992	All	24.00	n/a
1993	All	30.00	25.0%
1994	All	36.00	20.0%
1995	All	42.00	16.7%
1996	1,000 square metres or less	42.00	-
1997	1,000 square metres or less	43.20	2.9%
1998	1,000 square metres or less	44.40	2.8%
1999	1,000 square metres or less	45.60	2.7%
2000	1,000 square metres or less	46.80	2.6%
2001	1,000 square metres or less	48.00	2.6%
2002	1,000 square metres or less	49.20	2.5%
2003	1,000 square metres or less	60.00	22.0%
2004	1,000 square metres or less	72.00	20.0%
2005	1,000 square metres or less	78.00	8.3%
2006	1,000 square metres or less	84.00	7.7%
2007	1,000 square metres or less	91.25	8.6%

Rate Comparison - Sample Residential Customer

The following chart compares the 2007 rates for Regina and other cities for a sample residential customer. The sample customer is a home owner who uses 360 cubic metres of water per year. The water consumption is typical for a family of two adults and two children, in a home with two bathrooms, a dishwasher and washing machine, on a lot with typical landscaping for Regina.

Sample Residential Customer - 2007 Rates

<u>Utility Bill Details</u>	<u>Regina</u>	<u>Calgary</u>	<u>Edmonton</u>	<u>Saskatoon</u>	<u>Winnipeg</u>
Water:					
Basic Charge	\$ 135.05	\$ 128.88	\$ 54.36	\$ 61.20	\$ 55.00
Volume Charge	<u>316.80</u>	<u>395.75</u>	<u>420.70</u>	<u>236.46</u>	<u>400.47</u>
Total Water	<u>451.85</u>	<u>524.63</u>	<u>475.06</u>	<u>297.66</u>	<u>455.47</u>
Wastewater:					
Basic Charge	102.20	104.16	59.64	146.20	-
Volume Charge	<u>230.26</u>	<u>215.06</u>	<u>341.78</u>	<u>61.20</u>	<u>567.00</u>
Total Wastewater	<u>332.46</u>	<u>319.22</u>	<u>401.42</u>	<u>207.40</u>	<u>567.00</u>
Drainage or Infrastructure Levy	<u>91.25</u>	<u>68.76</u>	<u>99.53</u>	<u>95.40</u>	<u>-</u>
Total Annual Utility Charges	<u>\$ 875.56</u>	<u>\$ 912.61</u>	<u>\$ 976.01</u>	<u>\$ 600.46</u>	<u>\$ 1,022.47</u>

Rate Comparison - Sample Commercial Customer

The following chart compares the 2007 rates for Regina and other cities for a sample commercial customer. The commercial customer has a 40 mm meter, uses 3,000 cubic metres of water per year, with a property size in the range of 3,001 to 5,000 m². This water consumption would be typical for a strip-mall with a restaurant and a hair salon with a parking lot and minimal landscaping.

Sample Commercial Customer - 2007 Rates

<u>Utility Bill Details</u>	<u>Regina</u>	<u>Calgary</u>	<u>Edmonton</u>	<u>Saskatoon</u>	<u>Winnipeg</u>
Water:					
Basic Charge	\$ 244.55	\$ 324.60	\$ 190.44	\$ 876.00	\$ 85.80
Volume Charge	<u>2,640.00</u>	<u>2,876.58</u>	<u>2,392.98</u>	<u>1,565.00</u>	<u>2,874.36</u>
Total Water	<u>2,884.55</u>	<u>3,201.18</u>	<u>2,583.42</u>	<u>2,441.00</u>	<u>2,960.16</u>
Wastewater:					
Basic Charge	189.80	134.04	59.65	876.00	-
Volume Charge	<u>2,293.20</u>	<u>1,826.40</u>	<u>2,848.20</u>	<u>1,421.60</u>	<u>4,727.92</u>
Total Wastewater	<u>2,483.00</u>	<u>1,960.44</u>	<u>2,907.85</u>	<u>2,297.60</u>	<u>4,727.92</u>
Drainage or Infrastructure Levy	<u>357.70</u>	<u>68.76</u>	<u>895.73</u>	<u>468.60</u>	<u>-</u>
Total Annual Utility Charges	<u>\$ 5,725.25</u>	<u>\$ 5,230.38</u>	<u>\$ 6,387.00</u>	<u>\$ 5,207.20</u>	<u>\$ 7,688.08</u>

Water

Initiatives for 2007

- Commission the new pumps at the Buffalo Pound Water Treatment Plant. Three new pumps have replaced existing pumps originally installed in the 1950s and the 1960s. Two pumps installed in the early 1990s have been modified to achieve peak pumping efficiency, while one new pump has been installed to increase the peak day pumping rate by approximately 33%. Once the new pumps are operational annual pumping costs will decrease by approximately 50%. Starting in 2007 **all of the water supply for the city will come from the Buffalo Pound Water Treatment Plant.** The City will only use its ground water supply in an emergency.
- Complete the Leak Detection and Management Project with the National Research Council's Centre for Sustainable Infrastructure Research in Regina. This project uses computerized leakage detection and district metering in three sections of the City's water distribution system to study the integrity of asbestos cement and polyvinyl chloride watermains. Preliminary results indicate high leakage rates occur if fire hydrants are not closed properly. Field work in 2007 will determine the effectiveness of leakage management initiatives.
- Complete the assessment of the performance of asbestos cement (AC) watermains. This work is being done in conjunction with the National Research Council's Centre for Sustainable Infrastructure Research in Regina, under the Communities of Tomorrow partnership. The number of breaks in AC watermains increases dramatically during dry weather conditions such as the summer and fall of 2003, resulting in high costs for repairs. The assessment will determine the cause of the failures, whether there are ways to minimize future breaks, and alternatives available for providing a long term solution.
- Decommission a number of old and unused wells. These wells are no longer required due to increased supply capacity from the Buffalo Pound Water Treatment Plant. Newer, good condition wells are being kept for emergency water supply.
- Develop an asset management strategy for the repair and replacement of asbestos cement watermains and plastic service connections.

Status of 2006 Initiatives

- Completed the Long Term Water Utility Study Update to identify required improvements and upgrades. The original study was completed in 1993 and recommended numerous improvements to the water supply, water pumping and water distribution system, many of which have been completed. The Study Update reviewed portions of the water system that are affected by changes to water demand trends, water quality regulations and other factors.
- 54.2 metres of cast iron water mains were replaced in intersections.
- 157.3 metres of watermains were constructed to eliminate 4 dead ends and improve water flows for fire protection.
- 9 fire hydrants were replaced as part of maintenance, and 14 hydrants were replaced on roadway improvement projects.

Water System Overview

The water supply, pumping and distribution system provides water for residential and commercial use and fire protection. The system serves a population of over 190,000 including all residents and businesses in the city limits and a number of customers outside the city. Service goals include:

- Providing water that meets or exceeds Provincial water quality standards and objectives.
- Providing water at adequate pressure and in sufficient quantity to satisfy the requirements for domestic and commercial use, irrigation and fire protection.
- Identifying and implementing improvements to the water system through long range planning, monitoring, improved operation, capital works and new technology.
- Participation in Communities of Tomorrow and National Research Council's Centre for Sustainable Infrastructure Research to develop new technologies and improve practices.

Components of the water system shown in the map on the next page include:

- **Buffalo Pound Lake and Wells** – All of the annual water needs are provided from Buffalo Pound Lake. There are wells available for backup purposes. The well water is chlorinated, but does not require further treatment to meet current health standards.
- **Buffalo Pound Water Treatment Plant** – Water from Buffalo Pound Lake is drawn from the lake and pumped three kilometres to the Buffalo Pound Water Treatment Plant, a facility owned jointly with the City of Moose Jaw. At the plant, the water is mixed with coagulants that cause algae, bacteria and other impurities to clump together so that they settle out of the water. The water is then filtered and chlorinated. During warmer weather, the water is passed through granular activated carbon to improve the taste and odour.
- **Supply Pipelines** – From the Buffalo Pound Water Treatment Plant, the water is pumped through a 56 kilometre pipeline to the City's water distribution system. The pipeline has been twinned to provide increased capacity and reliability of the water supply. A number of other supply pipelines transport water from wells to reservoirs.
- **Reservoirs** – Five storage reservoirs are used to store water to meet peak demands and ensure that there is an adequate supply of water available for firefighting. The reservoirs have a combined usable storage capacity equal to about one and one-half days of average water use.
- **Pumping Stations** – There are three pumping stations (North, Farrell and Ross) that are used to pump water from reservoirs into the distribution system as necessary.
- **Distribution System** – The distribution system consists of over 785 kilometres of pipelines ranging in size from large 1,067 mm diameter trunk mains to 100 mm distribution pipes. The pipelines are made of various materials – asbestos cement, coated steel and polyvinyl chloride (PVC). The distribution system also includes over 6,000 valves that allow the water to be turned off to facilitate repairs and maintenance.
- **Service Connections** – Distribution pipes are connected to a customer's water line through a service connection.
- **Water Meters** – Water meters measure water consumption. A water meter replacement program was completed in 2004. The project included the installation of automated meter reading (AMR) equipment to transmit meter readings to a mobile data collection unit.

WATER SYSTEM

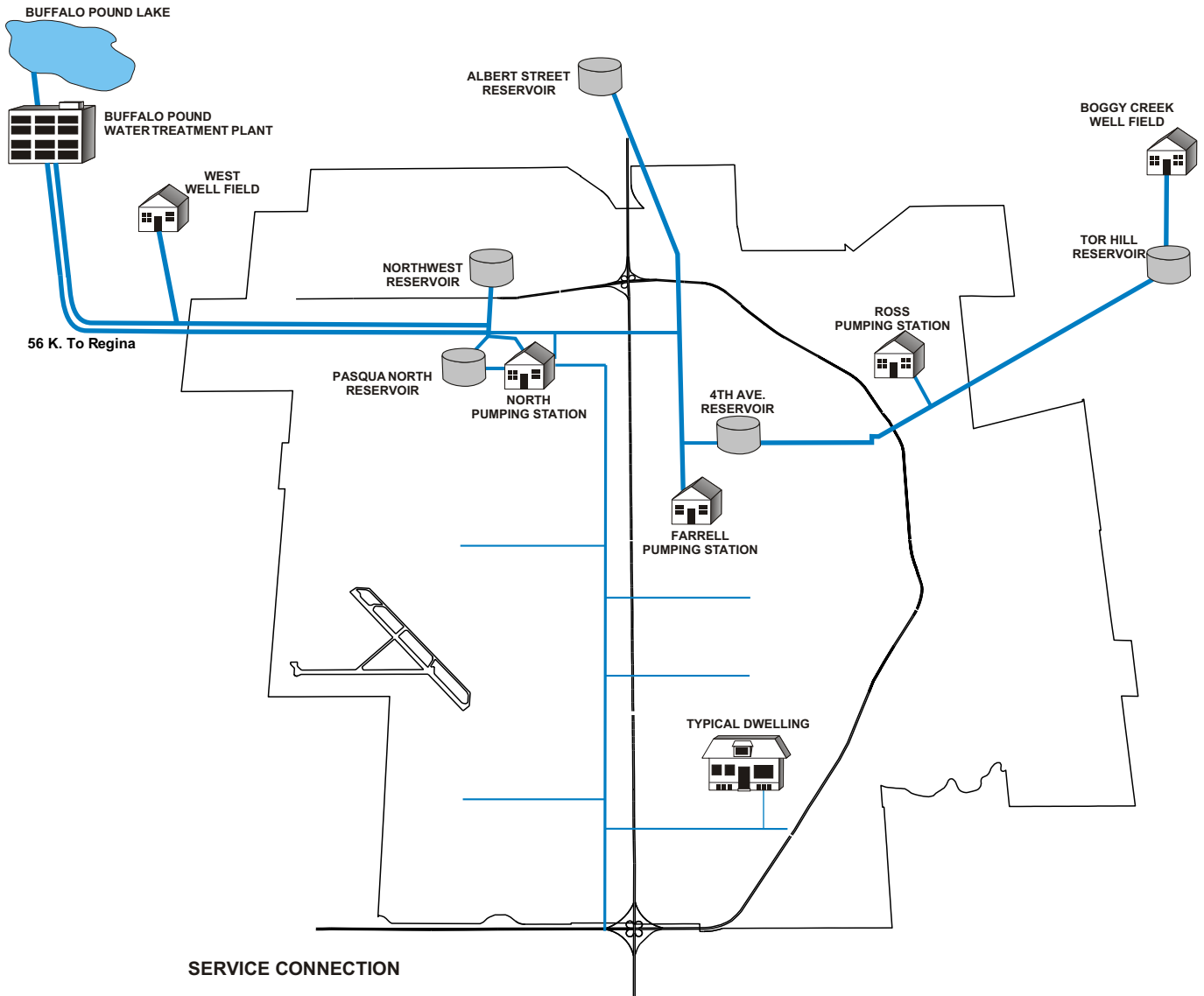

SERVICE CONNECTION

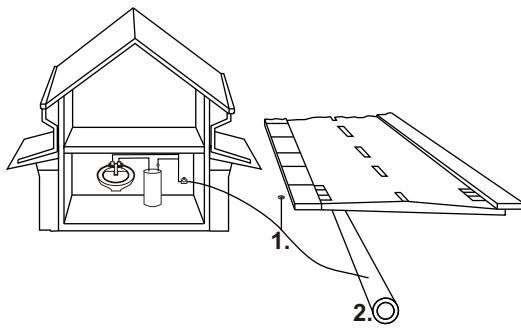

1. Service Connection (Curb Box)
2. Watermain

— Supply System
— Distribution System

Water System Objectives

The Long Term Water Utility Study, initially completed in 1993, covered all aspects of the water system, including projected future water requirements, the condition of the existing system components, and a review of the system operations. The Study was adopted by City Council as the City's long term water supply plan. In 1998, a portion of the Study was updated and resulted in a decision to improve the Buffalo Pound supply pipeline and pumping system rather than construct a ground water treatment plant. A Study update was completed in 2006 and provided recommendations for water system improvements for the next 20 years.

As part of the Study, a number of objectives were established. These objectives continue to guide the water system operations today, and include:

- **Water Quality** – The City adopted the *Guidelines for Canadian Drinking Water Quality, 4th Edition* published by Health Canada as the basis for its water quality objectives. These are the most complete guidelines established in Canada. The standards, adopted by Saskatchewan Environment, regulate the operation of all waterworks in Saskatchewan.

For parameters not included in the *Guidelines*, the City has adopted the most stringent level listed by other authorities. Some parameters are for substances for which there are aesthetic concerns rather than health concerns, such as iron, manganese and hardness. Other parameters are for substances to which health concerns have been linked but not proven, such as aluminum and trihalomethanes.

- **Water Conservation** – An enhanced Water Conservation Program was initiated in 1991 to reduce the per capita water consumption and the short term peak water demand. Reduction of water demand was recognized as a strategic means for postponing capital expenditures for the expansion of both water and wastewater treatment facilities. Targets for reduction of average day and peak day water consumption (as compared to the projections in 1992 for specific future years) were a 5% reduction by 1996, a 10% reduction by 2001 and a further 15% reduction by 2011. These targets were confirmed in the Long Term Water Utility Study updated in 2006.

Water consumption figures indicate that since 1991, average water consumption has decreased 10% while the population has increased approximately 5%. The reduction for average day and peak day per capita water use (as compared to 1991) is 10% and 25% respectively.

- **Reliability** – The City established an objective for the reliability of delivery, defined as ensuring the water will be available within the limits of minimal local disruptions for system maintenance and rare large-scale disruptions due to unforeseen catastrophe. Specific objectives are:
 - Mandatory water rationing should occur less than one year in ten.
 - Service should be restored within 24 hours in the event of local service disruptions such as water main breaks and connection problems. This objective is achieved for 99% of incidents.
 - All reasonable steps should be taken to ensure that large-scale disruptions do not occur. These steps include ensuring that there is sufficient redundancy in the system so that alternate facilities can be used in the event of a failure in part of the system.
 - Alternate power sources must be available in the event of a main power failure.
 - Hydrants should be installed and maintained to meet the requirements of the National Fire Code.

- **Water Pressure** – Water must be delivered to customers under pressure. It is desirable to maintain pressure standards between a minimum and maximum range. The pressure under which water is delivered to a customer depends upon many factors, including the consumption by other customers, pumping capabilities, pipe size, velocity of the water through the system, and the design of the water system.

Water pressure can be controlled to a certain extent through the operation of pumps and other components of the system. However in some instances, system changes may be necessary to meet pressure standards.

As part of the Long Term Water Utility Study, desirable ranges for pressure and velocity were identified and system improvements were recommended where conditions fell outside of these ranges. The Long Term Water Utility Study Update includes recommendations for addressing lower pressures along the northern edge of the city.

- **Efficiency of Operations** – Electricity used in pumping water is a significant cost within the Water Supply, Pumping and Distribution budget. This cost is a factor of the efficiency of the pumps as well as the hydraulics of the system. Pumping operations are regularly reviewed to identify where system improvements or operational changes could reduce electrical costs. Changes are pursued when cost-effective.

Water Supply

Buffalo Pound Lake now provides 100% of Regina's water needs. The water is treated at the Buffalo Pound Water Treatment Plant, which is jointly owned by the cities of Regina and Moose Jaw. It was built in the 1950s in order to provide water for those two cities. The facilities are administered by the Buffalo Pound Water Administration Board, which consists of two members appointed by the City of Regina and one member appointed by the City of Moose Jaw.

Although the plant is operated as a separate entity, there is a high degree of communication and cooperation between the plant operators and the two cities.

On an annual basis, the Board establishes a general water rate. The rate is established on a cost-recovery basis. The 2007 rate has been set at \$169.47 for one million litres, a 6.9% increase over the 2006 rate. The increase is due primarily to rising costs for electricity and natural gas, increases in unit prices for alum and chlorine and equipment price increases.

Since Buffalo Pound Lake is shallow and prone to the growth of algae and other organic materials, treatment of the lake water is challenging. Over the last ten years, the lake water has shown a trend of progressively higher levels of organic materials, which require higher levels of chemicals and carbon filtration in order to provide water that meets the City's water quality objectives.

The City's estimated 2007 cost of water purchased from Buffalo Pound will total approximately \$5.3 million, or about 40% of the total costs of the Water Supply, Pumping and Distribution Program.

Future planning for the plant must address new and anticipated regulations related to health effects. The review and update of the City's Long Term Water Utility Plan includes a Study of the Buffalo Pound Water Treatment Plant. Results of the Study include:

- **Disinfection** – The plant uses chlorine for treatment and disinfection. Chlorinating naturally occurring organic material results in the formation of disinfection by-products known as trihalomethanes and haloacetic acids which are harmful to human health. While Regina's water meets the requirements for total trihalomethanes, the concentration of one trihalomethane slightly exceeds the Health Canada Guideline for part of the year. The Study recommends reducing the use of chlorine if possible in

conjunction with the addition of ultraviolet light disinfection which is effective in reducing risks associated with cryptosporidium. Monitoring of cryptosporidium in lake water is required prior to the start of detailed design.

- Taste and Odour Control – The plant uses granular activated carbon and powdered activated carbon to control taste and odour generated by algae in Buffalo Pound Lake. The percentage of time that taste and odour control is required has been increasing for a number of years. The Study recommends that a detailed analysis of additional contactors versus additional storage for granular activated carbon be carried out prior to making a final decision.
- Wastewater Residuals Management – The treatment processes remove particulate matter along with approximately 6% of the total water volume from the lake water. This wastewater must then be either treated and disposed to the environment or recycled as much as possible through the water treatment plant. The existing wastewater lagoons are overloaded. The Study recommends that a portion of the wastewater be recycled through the water treatment plant, thereby reducing the loading on the existing lagoons, and that water from the lagoons also be recycled.
- Water Stability – Treated water is slightly corrosive which leads to the softening of concrete tanks in the water treatment plant and the slow deterioration of piping and fittings in the water distribution system which contains metal. Corrosion control in the form of protective coatings for concrete tanks and pH adjustment of treated water is recommended in the Study.

A Waterworks System Assessment (WSA) was completed for the Buffalo Pound Water Treatment Plant and Regina's Water System in 2005. WSA's are required every five years in accordance with Saskatchewan Environment's 2002 Water Regulations. The WSA evaluates current performance, level of optimization, functionality, capability, efficiency and sustainability of the waterworks and identifies required improvements.

As part of the total water purchase costs the two cities also contribute an amount equal to 10% of the general water charges to a Capital Replacement Reserve used to pay for replacement and upgrading of equipment in the plant.

Costs for major improvements to the plant are shared with the City of Moose Jaw. The cost-sharing ratio is determined by the percentage ownership of each City, which at the present time is approximately 73% for Regina and 27% for Moose Jaw.

Water Purchase Statistics	2002	2003	2004	2005	2006
Purchases (mega litres)	27,180	29,828	27,021	26,799	28,138
General Rate (\$/mega litre)	136.16	138.88	150.87	154.81	158.59
Capital Replacement Program (10% of General Rates) (\$/mega litre)	13.62	13.89	15.09	15.48	15.86
Power (\$/kwh)	0.05471	0.05581	0.05748	0.05400	0.05751
Power (kwh) (000's)	4,887.3	6,435.6	4,939.3	4,895.7	5,948.6

Regina can also draw water from 18 wells located in and around the city. Wells currently are available for emergency water supply in the event of a failure in the Buffalo Pound Water Supply.

The well water meets current safety standards but has levels of iron, manganese and hardness that exceed the City's water quality objectives. These minerals can cause staining on fixtures, as well as the appearance of "discoloured" water. The minerals also cause problems by forming deposits in the water system, requiring more frequent maintenance.

Water Supply by Source (in mega litres)	2002	2003	2004	2005	2006
Well Fields:					
West Wells	-	59	-	-	-
Boggy Creek	-	233	-	-	20
Total Water From Wells	-	292	-	-	20
Buffalo Pound Water Treatment Plant	27,180	29,828	27,021	26,799	28,138
Total City Water Supply	27,180	30,120	27,021	26,799	28,158
Percentage of Supply By Source:					
Wells	-	1.0	-	-	0.1
Buffalo Pound	100.0	99.0	100.0	100.0	99.9
Total	100.0	100.0	100.0	100.0	100.0

A number of tests are carried out to ensure that the water meets the water quality objectives. Tests include:

- At the Buffalo Pound Water Treatment Plant over 25,000 tests are performed each year to check for over 65 different substances. On-line analyzers and laboratory staff conduct the tests. In addition, some testing is done by outside labs. The cost of these procedures is included in the general water rate for water purchased from Buffalo Pound.
- Tests are also carried out at various points in the City's water supply and distribution system. Regular sampling and testing is done in order to comply with provincial requirements for the operation of the water system, as well as to ensure the City's water quality objectives are met.

Test results show that the water supply meets all health and safety guidelines. Instances have occurred where water quality did not meet the water quality objectives for iron and manganese from well water. Customer complaints also indicated the presence of discoloured water.

In addition to carrying out testing of treated water, steps are taken to safeguard the water supply. Identification and prevention of possible sources of groundwater contamination is an ongoing process. The City participated in a review of the Upper Qu'Appelle River watershed started by Saskatchewan Watershed Authority in 2004.

Water Pumping

Three pumping stations are used to pump water from reservoirs into the distribution system. The operation of all stations must be coordinated along with supplies from Buffalo Pound and other components of the supply system such as the reservoirs. Since electrical costs are a major component of this operation, it is important that the pumps are operated in an efficient manner. Water pumping must also be provided when electrical power failures occur.

In order to coordinate the operation of each station and to operate the pumps in an efficient and reliable manner, system data is required. This information is obtained from a computerized Supervisory Control and Data Acquisition (SCADA) system.

Water Distribution

The water distribution system consists of buried pipelines made of cast iron, asbestos cement (AC), or polyvinyl chloride (PVC). Steel is used for large supply mains exceeding 500 mm in diameter. Cast iron pipe was installed from 1904 until the 1940s. Asbestos cement was used throughout the 1950s, '60s and '70s. AC and PVC pipe comprise 70% and 30% respectively of the 790 kilometre distribution system. Approximately 107 kilometres of cast iron pipe has been replaced with PVC pipe since 1980. Some cast iron pipe remains due to location and size considerations (intersections, 600 mm diameter and over) and will be replaced as the need and opportunity arises. PVC pipe repair costs are virtually nil. The replacement of cast iron pipe with PVC pipe has allowed for significant savings in maintenance repairs.

Watermain breaks are a primary cause of water service disruptions, water losses and discoloured water. The frequency of breaks is a function of the pipe materials. The distribution of each material in the system and its failure rate is as follows:

Type of Pipe	Length in Kilometres	Percentage of Total	Failure Rate
Cast Iron	2	0.2	1.8
Asbestos Cement	535	67.9	0.2
PVC	215	27.2	-
Steel	37	4.7	-
Total	789	100.0	0.2

Note: The failure rate is calculated as the number of breaks per kilometre of pipe per year. The failure rate for cast iron pipe is the average failure rate for the years 1980 through 2001.

Watermain Statistics	2002	2003	2004	2005	2006
Main Leaks Repaired (#)	92	341	98	65	183
Average Unit Repair Cost (\$)	7,051	6,962	7,311	8,705	6,418

Note: The increase in the average per unit cost in 2004 and 2005 is the result of more locations requiring pipe replacements rather than clamp repairs.

Full circle stainless steel repair clamps can be used to repair small holes and cracks. Larger breaks are more costly to repair, as the damaged section of the main must be removed and new pipe installed. Both types of repairs require the water to be shut off to that section of the main. Customers are notified of the disruption in service.

A new watermain flushing process was successfully applied to the distribution system starting in 1998. The process has proven to be considerably more effective in removing iron deposits. The process involves closing valves to ensure the water flowing to the one isolated hydrant is coming from only one direction. This uni-directional flushing process increases the flow velocity to the point where all removable iron deposits are flushed from the pipes. Although uni-directional flushing cost is greater on a unit cost basis, it can be applied less frequently.

The existing water distribution system has a number of "dead ends", which cause problems in the operation of the system. In order to maintain uniform pressures in the system, ensure high water quality, and provide adequate flow to fire hydrants, dead ends should be avoided. Where possible, the watermains should be "looped", or connected to another line. This is possible in fully developed areas where there are other lines with which to connect. However, it is not practical to do this in areas on the edge of the city or cul-de-sac's.

The City has an ongoing capital program that addresses the reduction of the number of dead ends, thereby increasing the security of the overall system.

The water distribution system includes over 6,000 valves. The valves should be in working order to shut off the water for repair and when flushing watermains. The valves are checked periodically and repaired or replaced as necessary. In many cases, the valve is functioning properly but the casing surrounding the rod used to turn the valve is damaged or filled with dirt. A new method of excavation, called hydro-excavation, uses high pressure water and vacuum to loosen and remove soil for repair access. The method is quicker and leaves a smaller excavation. Traditional excavation methods are applied where the entire valve requires replacement.

Watermain Valve Statistics	2002	2003	2004	2005	2006
Valves Replaced (#)	38	40	20	28	24
Unit Replacement Cost (\$)	5,475	5,636	5,833	5,902	6,416
Valves Repaired (#)	89	80	83	78	67
Unit Repair Cost (\$)	1,607	2,393	1,359	1,429	1,760

The City operates a system of fire hydrants in order to provide water for firefighting purposes. The National Fire Code sets out standards for fire hydrants, and indicates that regular maintenance is required. The City uses *Water Supply for Public Protection – A Guide to Recommended Practice (1981)* published by the Fire Underwriters Survey as its standards for fire hydrant inspection and maintenance. These standards include checking hydrants on a regular basis to ensure they are functioning properly and available for use in the event of a fire; repairing and replacing any malfunctioning hydrants; repainting each hydrant every five years; and installing hydrants in new areas to ensure a hydrant is available within the specified distance of all buildings. The parts from damaged or obsolete hydrants taken out of service are salvaged and reused whenever possible.

Hydrant Statistics	2002	2003	2004	2005	2006
Hydrants in Service (#)	3,861	3,898	3,949	3,991	4,003
Hydrant Replacements (#)	19	16	11	15	9
Unit Replacement Cost (\$)	8,492	8,505	8,356	9,271	9,565

The unit cost is for an emergency replacement, and does not include the cost of a hydrant lead pipe, or temporary water supply to customers while the water is turned off. When hydrants are replaced during planned work the cost is approximately \$10,000 which includes a new lead pipe, valve and temporary water supply.

Work done on service connections range from minor repairs at the curb box, to the repair or replacement of the entire service connection. Water must be turned on and turned off at the customer site for reasons such as transfer of ownership of a home, new customers, breaks in waterlines on the customer's property and unpaid accounts. The water is turned on and off by turning a rod attached to the valve beneath the soil surface. At times, these rods and valves (curb boxes) may first have to be repaired. One 24-hour emergency service crew handles water leaks, complaints and other trouble calls. Lower unit costs for curb box repairs have been possible since 1998 with the introduction of hydro excavation.

Service Connection Statistics	2002	2003	2004	2005	2006
Connection Leak Repairs (#)	298	438	385	267	374
Unit Repair Cost (\$)	3,788	4,111	3,708	3,599	3,499
Curb Box Repairs (#)	553	714	627	669	604
Unit Repair Cost (\$)	793	799	824	907	1,008

Customer complaints or meter readers identify problems with water meters. The problems are typically investigated in the field by meter shop staff. New meters are installed to replace malfunctioning meters, as well as for new customer sites. Meter interface units are installed on all meters so that readings can be obtained with the AMR system.

Meter Installation and Repair Statistics	2002	2003	2004	2005	2006
Meters in Service (#)	60,200	59,716	60,158	60,731	61,500
Meters Installed - City (#)	446	475	813	710	903
Meters Installed - Contractor	-	32,500	18,800	-	-
AMR Units Installed - Contractor	-	36,300	20,800	-	-
Meters Overhauled (#)	600	365	601	560	421
Service Calls (#)	5,082	4,331	6,162	5,292	5,157

Water Consumption

The 2007 budget is based on an estimate of billable water consumption of almost 24 million cubic metres. About 62% of the consumption (14.8 million cubic metres) is for residential properties, 11% (2.5 million cubic metres) for multi-residential properties, and 27% (6.5 million cubic metres) is for non-residential properties.

The City has had a Water Conservation Program since 1985 and initiated an enhanced program in 1991. The primary goals of the program are to reduce the average per capita water consumption and the peak day water use. The following table provides information on the total water supplied and water use.

Water Supply and Use	2002	2003	2004	2005	2006
Total Water Supplied (mega litres)	27,180	30,120	27,021	26,799	28,158
Average Water Use per capita per day (litres)	387	426	395	377	400
Winter Water Use per capita per day (litres)	351	353	367	350	371
Summer Water Use per capita per day (litres)	437	528	435	414	487
Peak Day Water Use (mega litres)	133	149	121	128	127

The Water Conservation Program continues to be successful. The average water consumption has been reduced by approximately 8.8% since 1991. The population of the city has increased by approximately 5% over the same period. Annual water consumption has decreased from a high of 35 million cubic metres in 1988 to an average of 24 million cubic metres since 1993. The following table provides the history of metered water consumption.

Metered Water Consumption

(Million Cubic Metres)

Year	Metered Water Consumption	Year	Metered Water Consumption
1992	26.2	2000	23.3
1993	23.9	2001	24.3
1994	23.1	2002	24.0
1995	23.4	2003	25.0
1996	24.9	2004	22.4
1997	25.5	2005	21.8
1998	24.4	2006	23.1
1999	23.9		

Note: Water from Buffalo Pound is measured in mega litres (millions of litres). Water consumption for customers is measured in cubic metres.

Water Quality Monitoring

Water quality monitoring activities include:

- Administering the Permit to Operate Water Works for operation of the water system, including water quality monitoring of all water sources and the distribution system, and maintaining records related to the safety and operation of the water system.
- Carrying out supplemental testing to gather water quality data from the water distribution system.
- Communicating information about water quality to the public.
- Efforts to protect the city's water source at Buffalo Pound Lake and the Regina area aquifers.

Water Loss Reduction

All water utilities experience a certain amount of water loss. Water loss is the sum of water leaks plus water usage that is not metered and thus not billed to a customer. Water used to suppress fires and some irrigation are examples of water use that is not metered. Water lost through watermain breaks is an example of leakage and is part of the "unavoidable real losses" from the water distribution system.

In 2006, the City of Regina changed the method for reporting water loss. The International Water Association (IWA) Water Loss Task Force has produced an international best practice standard approach for water balance calculations and the estimation of water loss. This best practice has also been adopted by the American Water Works Association (AWWA) and by the Federation of Canadian Municipalities (FCM) InfraGuide Best Practice "Water Use and Loss in Water Distribution Systems".

The international best practice performance measure advocated by the IWA and AWWA is the Infrastructure Leakage Index (ILI). The ILI is defined as the ratio of Current Annual Real Losses (Real Losses defined as physical water losses from the pressurized system up to the point of customer consumption) to the Unavoidable Annual Real Losses (UARL defined as a theoretical reference value representing the technical low limit of leakage that could be achieved if all of today's best technology could be successfully applied). The ILI is a highly effective performance measure because it is:

- Based on a calculation that has been tested globally;
- Unit-less and based on real water loss;
- System specific taking into account operating pressure, service connection length, pipe condition and water meter location; and
- Comparable to an international data set.

To date, 19 municipalities in Canada that are participating in water system benchmarking have or are undertaking this method of determining an ILI index for their water distribution systems. Of the 13 municipalities that have completed the indexing for 2005, the index ranges from a low of 1.11 to a maximum of 4.19. The City of Regina has calculated an ILI of 2.97 for 2005 which places it in the middle of the ILI range for municipalities that have completed the calculation.

The calculated ILI of 2.97 for the City of Regina is within the “Good” Technical Performance Range of 2.0 to 4.0, but there is potential for marked improvements. For comparison purposes an ILI index of 1.0 to 2.0 is within the “Excellent” Technical Performance Range and indicates that further water loss reduction, although possible, may be uneconomical.

A Leakage Management Project was initiated in 2005 in Regina in cooperation with the National Research Council. In 2006 field work was done to determine the amount of water loss from two neighbourhoods in the city which have either Asbestos-Cement or PVC piping in their water distribution systems. The field work included establishing temporary district metered areas and using leak noise correlators to determine the leakage levels and to find hidden leaks. A preliminary result is that leaks from fire hydrant drains can be undetected and can be significant. In the case of one neighbourhood, flow from leaking fire hydrant drains were estimated to be 600 litres per minute. The leaking fire hydrants were attended to. Field work will continue in 2007 to look for other undetected leaks. Results from the Leakage Management Project will be used to develop plans to reduce water losses.

Water Volumes (million cubic metres)	2002	2003	2004	2005	2006
Total Water Supplied	27.2	30.1	27.0	26.8	28.1
Billed Consumption	24.0	25.0	22.4	21.8	23.5
Unaccounted Water	3.2	5.1	4.6	5.0	5.0
Unaccounted Water as a Per Cent of Total Water Supplied (%)	11.80	16.90	17.00	18.66	17.79
Infrastructure Leakage Index	-	-	-	2.97	-

Water Conservation Program

The Water Conservation Program consists of identifying information that should be provided to the public on methods of conserving water, and communicating the information by means such as:

- Brochures.
- Web page information.
- Appearances on local television and radio shows.
- School visits.
- Appearances at local trade shows, such as the Home and Garden Show.
- Xeriscape landscaping workshops.

A survey of Regina residents to determine levels of awareness and participation in water conservation was carried out in late 1998. The survey indicated that nearly three-quarters of Regina residents practice water conservation, over half recall promotion of water conservation, and a significant number felt water conservation advertising made them more likely to conserve water. Awareness of and adherence to the outdoor watering schedule fell somewhat from the previous survey.

Water conservation efforts have been effective to date. As part of the Long Term Water Utility Study, water consumption was predicted both with and without the impacts of a Water Conservation Program. The next table shows the impact of conservation efforts has been more successful than predicted.

Water Consumption	Study Predictions for 2001 with Water Conservation	Study Predictions for 2001 without Water Conservation	2006
Annual Average Per Capita ⁽¹⁾ (litres per capita per day)	513	564	400
Annual Average Day (million litres)	98	109	77
Peak Day (million litres)	244	271	127
Peak 3-Day (million litres per day)	191	212	123
Population Estimates	200,408	200,408	196,100

Note: Per capita water consumption is the entire volume of water used by all customers, including industrial and commercial, divided by the population.

A portion of the decrease can be attributed to factors such as reduced industrial water use, revised population figures, increases in water rates and weather conditions. However, water conservation is a significant factor.

Cross Connection Control and Backflow Prevention Program

Water quality can be compromised by the introduction of contaminants into the distribution system. This can occur wherever there is a cross connection, which is a link between the drinking water supply and the source of contamination such as a pesticide container on a garden hose or a boiler filled with anti-corrosion chemicals. Various conditions can cause backsiphonage and/or backpressure in the water supply system. This can cause the domestic water to move in the opposite direction and take with it any materials it is in contact with or mixed with. The result is the water supply to a building or neighbourhood becomes polluted or contaminated.

The Cross Connection Control and Backflow Prevention Program was established in 1996 to reduce the possibility of contamination from such causes. Since the program was established, all new facilities have been reviewed for backflow prevention requirements through the building permit process. The 3,000 existing commercial, institutional and industrial facilities are being inspected by the City. Any backflow requirements are identified and a one-year time frame given to become compliant.

The four primary components of the program are:

- Public education and awareness.
- Inspections of 3,000 commercial, industrial and institutional facilities.
- Administration of the annual testing of testable backflow prevention assemblies.
- Review of appropriate building permits for new facilities.

**Cross Connection Control and Backflow
Prevention Statistics**

**Program Inception
to December, 2006**

Existing Facilities Inspected	1,988
New Facilities (Building Permits)	812
Existing Facilities Inspected and Compliant	1,723
Existing Facilities Inspected and Non-Compliant in the Current Year	64
Existing Facilities Inspected and Still Non-Compliant after One Year	1,188
Testers Licensed	91

Wastewater

Initiatives for 2007

- Complete the CCTV inspection and trenchless rehabilitation of approximately 20 km of wastewater mains.
- Complete the detailed design and construction of the Wascana Valley Trunkmain lining project.
- Complete the cleaning and CCTV inspection of several siphons.
- A sewer and water inspection and repair policy will continue to be developed that will address requirements for the frequency of inspection and repair of utility assets. Once complete, the policy will assist in settling claims arising from breaks or backup from sewers and water lines and interruption of service. The sewer line cleaning and frequency would be stated in the policy to ensure the community that this asset is in reasonable operating condition, relative to industry standards and other maintenance operations.
- Engineering pre-design studies are planned to start in 2007 for the wastewater treatment plant upgrade/expansion project.
- Detailed engineering for design and implementation of the methane gas utilization project is proposed to commence in 2007. This project will essentially fully utilize methane gas generated at the wastewater treatment plant thereby optimizing gas energy capture and utilization.
- Reconcile a work plan for future wastewater forcemains and gravity sewer trunks to the wastewater treatment facilities.
- Reinitiate a project for the conversion of wastewater treatment plant engineering drawings into digital format.
- Proceed with engineering pre-design and detailed design for a fully renewed wastewater screening system at McCarthy Boulevard Pumping Stations. MBPS delivers all wastewater to the treatment facilities.
- Proceed with integrity improvements to McCarthy Boulevard Pumping Station including valving, instrumentation, control, auxiliary equipment improvements.
- Assess options for the handling and facility improvement for liquid wastehaulers.
- Inspect and refurbish the concrete 54" diameter forcemain and inspect the 42" diameter oldest steel forcemain delivering wastewater flows to the wastewater treatment facilities.
- Rebuild and provide corrosion protection of concrete channels in the Primary Treatment Plant, Sedimentation building.
- Assess options and proceed with the design and implementation of ultraviolet disinfection equipment retrofits.

Status of 2006 Initiatives

- Completed a conceptual design for wastewater servicing in the southwest area of the city west of Lewvan Drive.
- Conversion of engineering drawings to digital format commenced in 2005 through contracted drafting services and continues in 2007.
- A long term planning study of sewage treatment requirements was completed in late 2005. In 2006, findings were reviewed and assessed in consultation with Saskatchewan Environment and capital budgeting developed to implement the recommendations.
- Completion of 14,975 metres of sewer cleaning and CCTV inspection, 3,871 metres of sewer lining and 136 locations of trenchless spot repair.
- Wastewater treatment biosolids reuse through landfill composting projects continued. Compost products will provide topsoil for landfill closure cover requirements.
- Remedial or preventative maintenance improvements on forcemains were completed including the secondary valve chamber and valve chamber bypass.
- The biosolids to agricultural land initiatives was curtailed in 2005 with all produced and stock-piled biosolids delivered for the landfill composting trial to produce topsoil for future landfill closure cover needs. Biosolids to agricultural land remains an approved alternative disposal option for the wastewater treatment plant in future years.
- Construction continued for a control and service building addition to the Wastewater Treatment Plant Administration Building. The building incorporates change rooms and lockers and replaces the temporary trailer office space for plant supervisory and technical staff. Construction is substantially complete.
- A Receiving Environment Study was undertaken and completed in 2006. This study examined water quality, aquatic biology and habitat in the downstream water bodies that accept the treated wastewater. The results of the study will be received in early 2007, and will be reviewed and assessed and utilized to guide future further proposed receiving environment assessment studies.
- The sewer and water inspection and repair policy has been incorporated into the asset management strategy for underground water and sewer infrastructure. Progress was made in documenting sewer practices for legal claims. The present benchmarking with other cities of the sewer infrastructure has been expanded in 2006 to include the water infrastructure.

Wastewater System Overview

The wastewater collection and treatment system collects sewage from residential, institutional, commercial and industrial customers in the city. Wastewater treatment and final effluent meet provincial environmental standards. Service goals include:

- Collecting residential, commercial and industrial wastewater in the city and delivering it to wastewater treatment facilities.
- Producing a treated wastewater effluent that is biologically and physically safe for the environment and which meets the requirements of the provincially issued operating permit.
- Ensuring solids removed from the wastewater are treated and disposed of in an appropriate manner.

Components of the wastewater system shown in the map on the next page include:

- **Service Connections** – Building plumbing systems are attached to the wastewater collection system by a service connection pipe. The City owns and is responsible for the maintenance of the service connection pipe on the “City side” of the property line.
- **Collection Mains and Trunk Mains** – The service connection pipes are attached to wastewater collection mains which are typically 200-250 mm in diameter. The collection mains drain into trunk mains which are 300 mm or more in diameter.
- **Manholes** – Over 15,000 manholes provide access to the wastewater collection system for maintenance and repair.

WASTEWATER SYSTEM

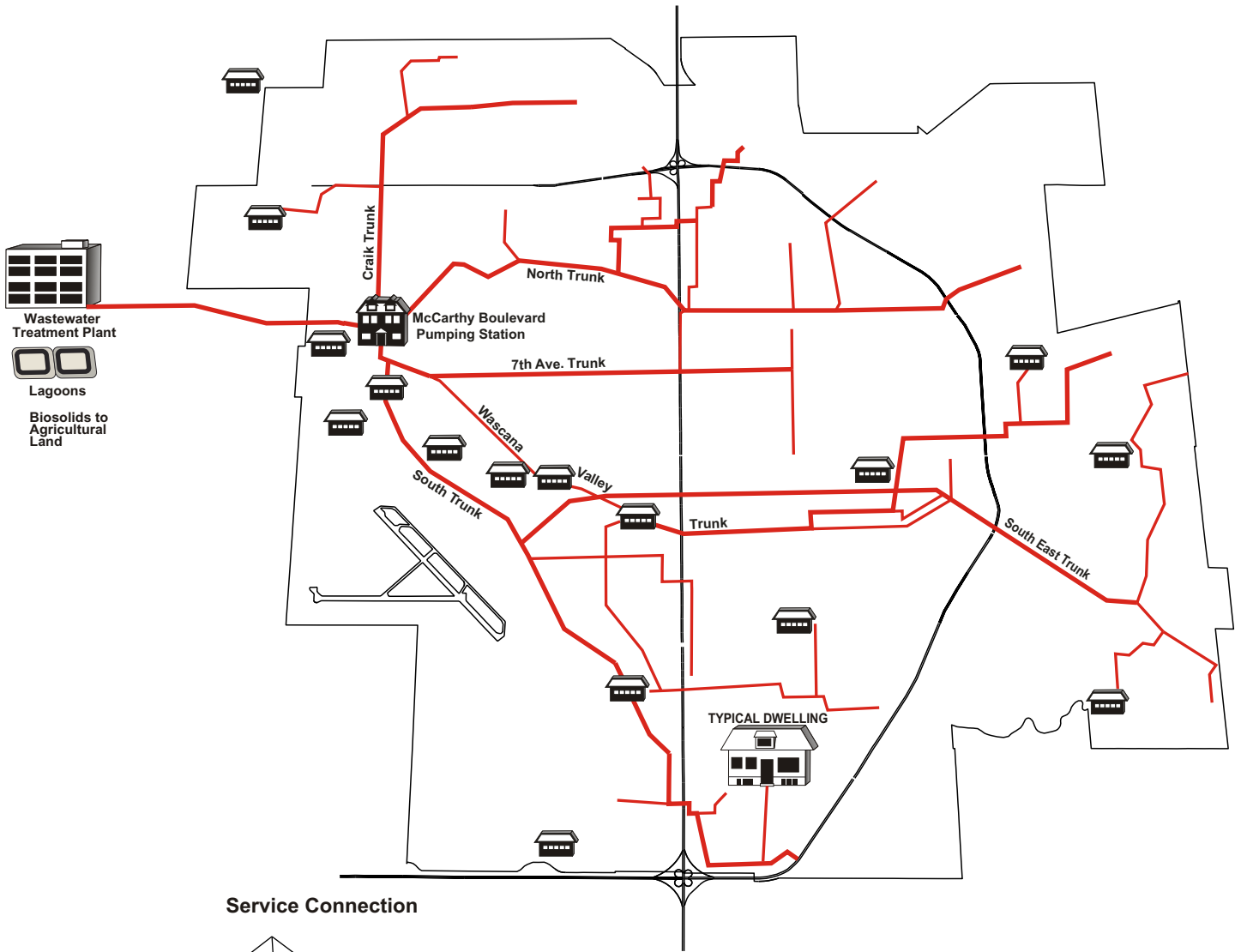

Service Connection

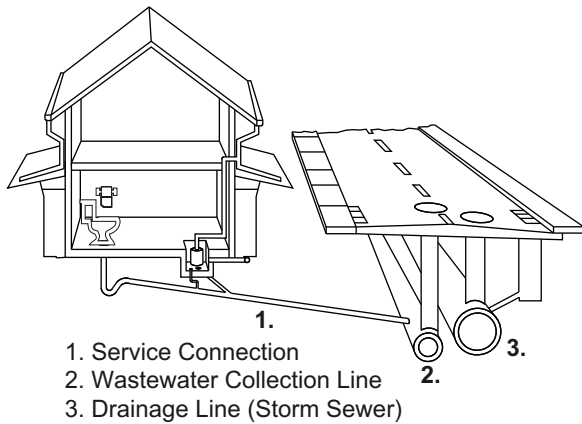

1. Service Connection
2. Wastewater Collection Line
3. Drainage Line (Storm Sewer)

- **Lift Stations** – Wastewater flows through the collection system by gravity. In low-lying areas in the city lift stations must be used to pump the wastewater to collection and trunk mains at a higher elevation. Wastewater then continues to flow by gravity from that point eventually reaching the McCarthy Boulevard Pumping Station. There are 16 lift stations in the wastewater collection system.
- **McCarthy Boulevard Pumping Station** – All wastewater collected in the city flows to the McCarthy Boulevard Pumping Station. The station provides screening and continuous transfer of wastewater from the collection system to the wastewater treatment facilities five kilometres west. The McCarthy facility is capable of transferring wastewater at up to five times the average daily rate. The station is also the location where commercial septic tank haulers offload into the wastewater system.
- **Wastewater Treatment Plant** – The plant processes wastewater through four stages of treatment:
 - Primary treatment removes sand, grit and organic material from the sewage.
 - Secondary treatment reduces dissolved organic material through the use of aerated lagoons.
 - Tertiary treatment removes phosphorus, algae and suspended solids by using aluminum sulphate and polymer.
 - Ultraviolet light is used to disinfect the effluent before it is released into Wascana Creek.

Wastewater System Objectives

The provision of wastewater collection and treatment services is critical to the health and environment of the citizens of Regina and surrounding area. Objectives for wastewater collection and treatment are:

- **Quality of Sewage Effluent** – Treated wastewater from the City's wastewater treatment plant is discharged into Wascana Creek, which flows into the Qu'Appelle River upstream from the town of Lumsden. Saskatchewan Environment establishes criteria for sewage effluent that each wastewater facility in the province must follow. The major criteria are total phosphorus, fecal coliform bacteria, biological oxygen demand and suspended solids in the treated effluent discharged to Wascana Creek.
- **Reliability of the Collection System** – Improperly functioning wastewater collection systems cause inconvenience, health and safety concerns. Problems such as blockages and leaks can result from deterioration of pipes, sags and breaks in wastewater collection lines and connections caused by shifting soil, tree roots and foreign materials in the lines. To prevent these problems regular inspection and maintenance programs are carried out.
- **Separation of the Drainage System from the Wastewater Collection System** – The wastewater collection and treatment system is adequate to handle the day-to-day wastewater flows from the city. During rainfall and snow melt events, drainage water enters the wastewater collection system through basement sump pits connected to weeping tile drainage, catch basins inadvertently connected to the wastewater collection system, and infiltration through pipe cracks and openings such as wastewater manhole covers. Reducing the amount of drainage water entering the wastewater collection system can postpone large expenditures required for trunk mains and treatment plant expansions. Work is being done to reduce infiltration to both new and existing wastewater mains and trunks.
- **Odour Control** – One of the by-products of wastewater treatment and collection is odour. Such odours are unpleasant for nearby residents and staff. Reduction of effective odours is accomplished by the use of containment, chemicals and aeration lagoons. The aeration equipment injects oxygen into the wastewater, preventing a septic environment that produces strong odours.

- **Efficiency of Operations** – Electricity is primarily required to operate pumps and aeration blowers at the wastewater treatment plant. Chemicals such as aluminum sulfate and polymer used to remove phosphorus are a significant cost of operating the wastewater treatment plant. To minimize costs, it is important to make effective use of chemicals required to meet effluent targets. The most efficient use of electricity, chemicals and other inputs is accomplished by dynamic automatic process control and laboratory based performance information at all stages of the treatment process.
- **Maintaining Treatment Capacity** – Regina uses five aeration lagoons in its secondary treatment process. Over the years, as solids settle to the bottom of the lagoons and aeration systems deteriorate, capacity is diminished. To maintain treatment capacity, new lagoons must be built or old lagoons must be refurbished.

Wastewater Collection

To identify and prevent problems in the wastewater collection lines, the lines are cleaned and inspected, on average, once every seven years. Locations with chronic problems are cleaned more frequently with high-pressure water to dislodge grease and other matter and move this material into a holding tank. In conjunction with jet cleaning, lines are inspected through closed circuit television.

Sewer Maintenance Statistics	2002	2003	2004	2005	2006
Lines Cleaned - Jet Cleaning Program (metres)	70,170	68,223	65,770	67,627	47,426
Average Cost (\$/metre)	0.93	1.10	1.03	1.23	1.21
Main Repairs (#)	10	4	12	9	12
Average Cost (\$/repair)	4,705	3,515	3,647	6,755	6,517
Manhole Repairs (#)	103	80	57	71	70
Average Cost (\$/repair)	623	810	725	675	1,045

Service connections that break down or block too frequently are either repaired or replaced.

Wastewater Connection Statistics	2002	2003	2004	2005	2006
Connection Repairs (#)	28	34	37	41	38
Average Cost (\$/repair)	4,923	3,833	4,770	5,177	4,354
Connection Replacements (#)	60	83	107	92	103
Average Cost (\$/replacement)	5,162	5,936	6,118	5,669	5,829

The wastewater collection system includes the operation of 16 lift stations. Electricity is a significant cost in operating the lift stations. Ongoing electrical and mechanical equipment maintenance is required, in addition to general maintenance on the station buildings and grounds. A project to equip every wastewater lift station with Supervisory Control and Data Acquisition (SCADA) equipment was implemented in 2002.

Wastewater Treatment

The McCarthy Boulevard Pumping Station pumps all wastewater to the Wastewater Treatment Plant. High reliability and capacity are critical to ensure this facility does not cause sewer collection system backup. One of two electric pumps handles normal daily flows while three high capacity diesel pumps handle

extreme flow events, which happen when storm water infiltrates the sewer system during rainstorms or sudden snow melts. Screenings removed at the station are disposed of at the sanitary landfill.

McCarthy Boulevard Pump Station Statistics	2002	2003	2004	2005	2006
Total Annual Flow (Million Litres)	26,354	25,801	27,015	25,721	25,150
Bypass Flows (Million Litres) (Target: 0)	-	-	-	-	-
Screening Removal (Tonnes)	207	215	172	137	105

All wastewater is treated at the **primary treatment** plant. The plant uses settlement to remove solids from sewage. The City has established a target of 60% for suspended solids removal.

Treated sludge from the primary treatment process is stock piled on site for subsequent disposal. A target of >30% solids in the sludge has been set. A higher number means drier sludge, reducing hauling costs.

Primary Treatment Statistics	2002	2003	2004	2005	2006
Suspended Solids Removals (%) (Target >60.0)	64.2	57.2	62.0	62.0	60.6
Biological Oxygen Demand Removals (%) (Target >35.0)	39.4	27.6	35.0	33.0	34.3
Solids in Cake Sludge (%) (Target >30.0)	29.3	32.5	34.0	33.0	33.7
Tonnes of Sludge (Dry Weight)	1,834	1,382	1,646	1,655	1,568

The **secondary treatment** process that removes sewage organics measured as biological oxygen demand involves the use of aerated lagoons. Large blowers are used to force air through diffuser pipes and into the wastewater. Electricity is a major cost of this function. To prevent septic conditions and thereby reduce odours, a minimum of three parts per million dissolved oxygen is maintained in the lagoons. Higher oxygen transfer efficiencies reduce energy costs.

Secondary Treatment Statistics	2002	2003	2004	2005	2006
Oxygen Transfer Per Cent Efficiency					
Lagoon 1 South	4.1	5.1	3.8	3.0	4.2
Lagoon 2A	7.2	6.8	5.9	6.3	6.5
Lagoon 2/3	3.9	4.0	7.3	4.2	4.9
Average Lagoon Dissolved Oxygen Level mg/l	4.1	4.9	5.8	5.3	4.7

The **tertiary treatment** plant removes phosphorous, algae, suspended solids, bacteria and biological oxygen demand (BOD) from the lagoon effluent prior to disinfection and release of the treated effluent to Wascana Creek. The major expenditure is for liquid alum.

It is desirable to maintain a low alum to phosphorus ratio, as this is an indicator of how much alum is used in order to remove phosphorus as required to meet criteria established by Saskatchewan Environment. In wet years, plant flow capacity limitations degrades performance and partial bypassing may be required. The average effluent phosphorus requirement is ≤ 1.00 parts per million.

Tertiary Treatment Statistics	2002	2003	2004	2005	2006
Alum to Phosphorus Removal Ratio (Target <33.0)	43.50	33.05	39.21	34.7	25.6
Average Effluent Phosphorus (Target ≥ 0.90 & ≤ 1.00)	0.91	0.96	0.94	0.93	0.99
Bypass Flows (Target 0) ML	100	612.4	419	-	-

Disinfection of final effluent water prior to its release to Wascana Creek is performed by ultra violet light to reduce health risks to downstream water users.

Disinfection Statistics	2002	2003	2004	2005	2006
Average of Fecal Coliform Geometric mean counts/100 ml (weekly geometric mean permit is 100/100 ml)	16.8	36.2	40.7	20.4	9.5

The wastewater treatment plant laboratory does regular daily, weekly, and monthly tests at all stages of treatment to ensure effectiveness. Research and pilot treatment projects are also carried out. Testing is routinely carried out for over 50 different parameters. Samples are taken from 20 different sites on the Wascana Creek and the Qu'Appelle River system. Records of all tests and plant performance are maintained and distributed.

Test and Plant Record Performance	2002	2003	2004	2005	2006
Lab Analysis (#)	25,648	27,001	26,463	25,917	25,518
Treatment \$/Million Litres	172.15	186.29	167.36	175.95	184.92
Treatment \$/Tonne of Contaminants Removed	333.42	494.80	384.82	435.20	447.56
Treatment \$/Capita	24.08	26.12	23.14	23.47	24.12
Overall Contaminants Removed (%) Target > 90%	88.2	88.7	90.4	86.5	87.4

Wastewater Service Connection Refund Program

When customers report problems such as slow draining fixtures, they are instructed to contact a sewer service company to determine the nature of the problem, remedy it, and bill the customer directly. Upon presentation of the paid bill from the customer, with a complete description of the problem from the sewer service company, the City will provide partial or full reimbursement if a connection obstruction or back up occurred as a result of:

- A breakdown or severe sag in the service connection pipe on the City side of the property line.
- Blockage due to tree roots from trees on City property.
- Blockage due to tree roots from privately owned and City owned trees.
- A blocked wastewater collection main.

The total cost of reimbursements for 2006 is \$106,756 (2005, \$81,943). In recent years, City staff service connections when the problem is the City's responsibility to remedy. City staff serviced 1,411 connections in 2006.

Wastewater Service Refund Statistics	2002	2003	2004	2005	2006
Reimbursements (#)	2,002	1,524	1,366	960	1,200
Average Reimbursement (\$)	87	86	83	91	97

Drainage

Initiatives for 2007

- Complete the detailed design and begin construction of the Ring Road Lift Station.
- Complete the preliminary design for the Stewart Russell Storm Detention Project.
- Complete the CCTV inspection and trenchless rehabilitation of approximately 18 km of drainage mains.
- Complete the Drainage Master Study. The Study focuses on the adequacy of the creeks, drainage channels and detention/retention ponds in handling runoff from the 17 subdrainage areas in the city.

Status of 2006 Initiatives

- Completed a conceptual design for drainage servicing in the southwest area of the city west of Lewvan Drive.
- Completed Drainage Study for Area 12.
- Provided drainage system renewal/rehabilitation at roadway renewal locations.
- Continued the Home Flood Protection Education Program.
- Completed construction of the Dieppe Area drainage project.
- Completion of 13,689 metres of drainage main cleaning and CCTV inspection, 1,088 metres of lining and 79 locations of trenchless spot repairs.

Drainage System Overview

The drainage system collects water from rainfall and melting snow in and around the city and leads it to Wascana and Pilot Butte Creeks. The system serves over 60,000 residential and commercial properties. Service goals include:

- Collecting and controlling drainage water within the city to minimize inconvenience, property damage and danger to the public.
- Monitoring the potential for flood conditions in Wascana Creek and the drainage channels and carrying out flood control measures as required.

The **Minor Drainage System** consists of the underground piping system that collects and transports small to medium amounts of drainage from rainfall, snow melt and minor storms. Components of the minor system include:

- Catch Basins – Over 25,000 catch basins located in streets and open space areas collect water and direct it into the drainage lines. Catch basins are designed to keep sand, silt and other matter out of the piping system by causing it to settle to the bottom of the catch basin.

- Lines, Mains and Trunks – There are approximately 700 kilometres of drainage lines located beneath streets. Lines and mains range from 200 mm to 1,200 mm in diameter, with trunks over 1,200 mm.
- Manholes – Over 15,000 manholes provide access to the system for maintenance and repair.
- Lift Stations – Drainage water flows through the system by gravity. There are low-lying areas where lift stations are used to pump the drainage water to a higher elevation. The water flows into a lift station at a low elevation, and is pumped to a higher level where it continues to flow through a pipe or channel. There are 11 lift stations in the drainage system.

The **Major Drainage System** is used when drainage water exceeds the capacity of the minor system and must flow over land. The major system is designed so that water will flow down roadways and land easements. Components of the major system include:

- Graded Roadways, Land Easements, Swales, and Lots – In order for the runoff water to flow over land to a point where it can be collected, the surface area must be properly sloped.
- Dry Bottom Detention Facilities – These are lower land areas constructed in open space areas such as parks. The detention facility contains outlets to and from the minor system. During periods of heavy rainfall, water that would otherwise overload the minor system enters the detention facility and is stored temporarily. The water from the detention facility then flows back into the minor drainage system at a later time when flows have gone down.
- Lake (or Wet) Retention Facilities – Lakes such as the ones in Lakeridge and Windsor Park are similar to dry bottom detention facilities, except they normally contain water all year for aesthetic reasons. When the minor system is overloaded, the water in these ponds rises, and then drops when the excess water flows back into the minor drainage system.
- Underground Detention Tanks – Underground detention tanks are also used, particularly in some of the downtown areas, to store excess water temporarily until it can be accommodated by the minor drainage system.
- Drainage Channels and Creeks – Drainage water empties into the drainage channels or Wascana Creek. The drainage channels function as very large drainage lines, with earthen banks used to control the water rather than enclosed pipelines. The drainage channels carry the runoff to Wascana Creek. Drainage from the Rowatt Flood Control Project south of Regina flows to Wascana Creek through constructed channel within the city limits.

Although the major and minor systems are described as separate systems, they are part of an overall drainage system and must work in conjunction with each other. The systems are depicted in the map on the next page.

Drainage System Standards

Standards for drainage system design are normally expressed in terms of the size and type of storm a system can theoretically handle. For example, a drainage system may be designed to handle a 1:5 year storm, which means that it can handle the size of storm that statistically only occurs once in five years in the area. A drainage system designed to handle a 1:100 year storm would be able to handle the size of storm that statistically occurs once in 100 years in the area.

Statistical information is obtained from the Atmospheric Environment Service of Environment Canada to determine storm sizes. In the past, rainfall data was only available from the airport, but three new data collection points have been added around the city since rainfall can vary significantly by area. Computer modelling is then done to determine the size of other storms.



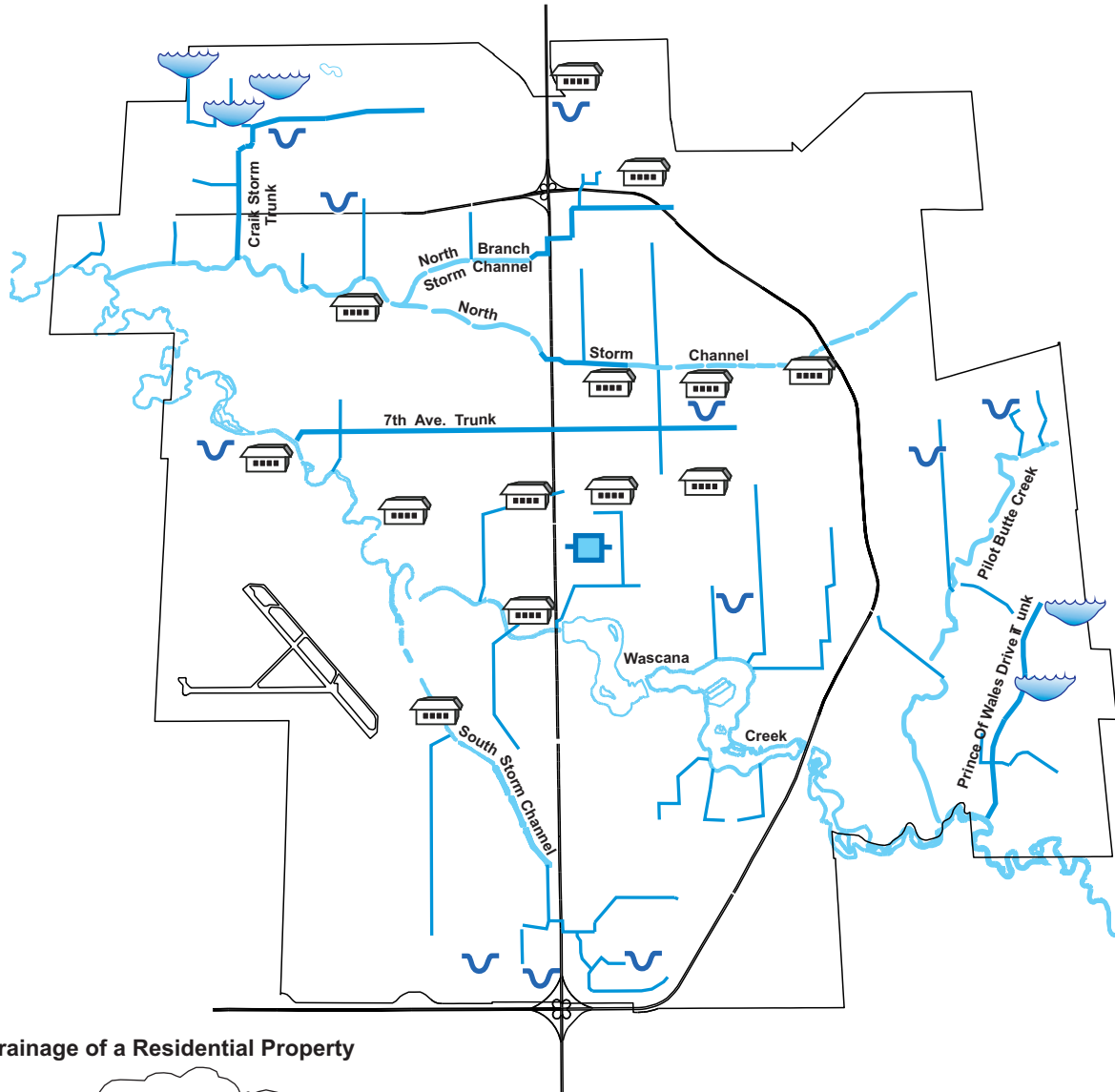

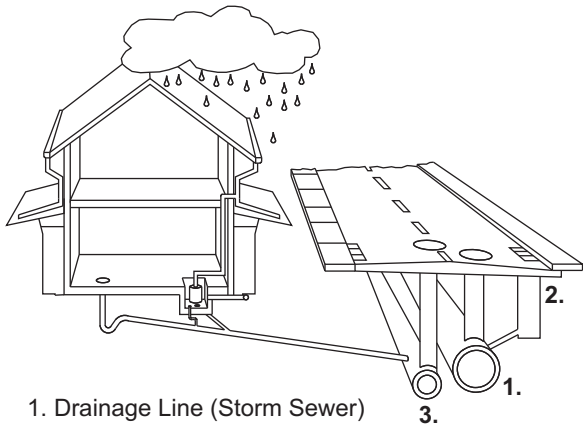

DRAINAGE SYSTEM



Drainage of a Residential Property



1. Drainage Line (Storm Sewer)
2. Catch Basin
3. Wastewater Collection Line

-  Lift Station
-  Retention Pond
-  Dry Bottom Detention
-  Underground Detention
-  Storm Sewer Main
-  Storm Channel

The following are some of the major rainstorms that have occurred in Regina over the past 30 years:

June 1975	1:25 year storm
July 1983	1:100 year storm (108 mm of rain in four hours)
June 1994	1:25 year storm
August 1995	1:25 year storm (severe hail)
July 2001	1:100 year storm (50 mm in one hour)
August 2004	1:100 year storm (76 mm in one hour)

Factors examined in determining the “size of storm” include:

- Total rainfall volume.
- Intensity of rainfall – a storm that drops 100 mm of rain in one hour is much more difficult to handle than one that drops 100 mm over six hours.
- Previous rainfall – if the ground is saturated before the storm, no additional water can soak in. Flows in the drainage system are therefore greater.

Standards for drainage systems have been raised over time, and have been applied to new developments. However, it is very costly to retroactively apply higher standards to existing development. Details of the standards include:

- **New Development Standards** – The “minor” drainage system consists of catch basins and underground lines that quickly collect and transport water. The “major” drainage system, consists primarily of aboveground facilities such as roadways, easements, swales, and detention and retention facilities that can handle larger volumes of water.

For new developments in the city, minor systems must be designed to handle a 1:5 year rainfall event. This corresponds with the general standard used across North America. While a higher standard would provide a higher level of service, the cost to construct underground facilities to handle larger storms is prohibitive. The major systems must be designed to handle a 1:100 year event. Until recently, the City had a minimum standard of 1:25 year event, but encouraged developers to target the 1:100 year event. This standard is now used in most larger prairie cities. The difference in costs between the two targets is not significant. As well, past experience has shown it is much more cost effective to design a new development to a high standard initially. Raising the standards in an area after it has been developed is very costly.

- **Existing Development Standards** – The City has adopted a target of 1:5 year events for existing minor systems, and 1:25 year events for existing major systems. Some areas of the city do not meet these targets. In the early 1980s, a program to study the drainage problems was initiated to identify solutions and carry out remedial measures to mitigate drainage issues. A Drainage Master Plan designating 17 areas was adopted. Conditions in each area are assessed, problems identified and potential solutions proposed. Over time, work required to address the problems is carried out through the capital program. The status of the studies is shown in the following table. A map showing the 17 areas is on the next page.

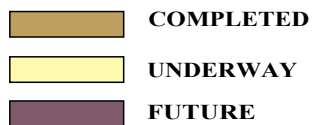
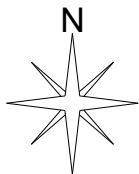

STUDY AREAS

- 1 7TH AVENUE/TRANSCONA (C)
- 2 SOUTH REGINA (C)
- 3 RIVERSIDE (C)
- 4 UPLANDS (C)
- 5 GLENCAIRN (C)
- 6 ARGYLE PARK (C)
- 7 WALSH ACRES (C)
- 8 ARNHEIM/ASSINIBOIA/DOUGLAS PARK/ETC (C)
- 9 ROCHDALE/SHERWOOD/McCARTHY (C)
- 10 OLD 33/WASCANA ADDITION (C)
- 11 CATHEDRAL/CPR ANNEX (C)
- 12 ROSS INDUSTRIAL/LANDFILL (C)
- 13 OLD 33/INDUSTRIAL PK/REGENT PK/ETC (C)
- 14 LAKEVIEW/HILLSDALE/WASCANA CENTRE/ETC (C)
- 15 MT. ROYAL/DIEPPE/NORMANVIEW/ETC (C)
- 16 UNIVERSITY PK/GARDINER PK/ETC (C)
- 17 PIONEER VILLAGE/EXHIBITION GROUNDS/OLD 33 (C)

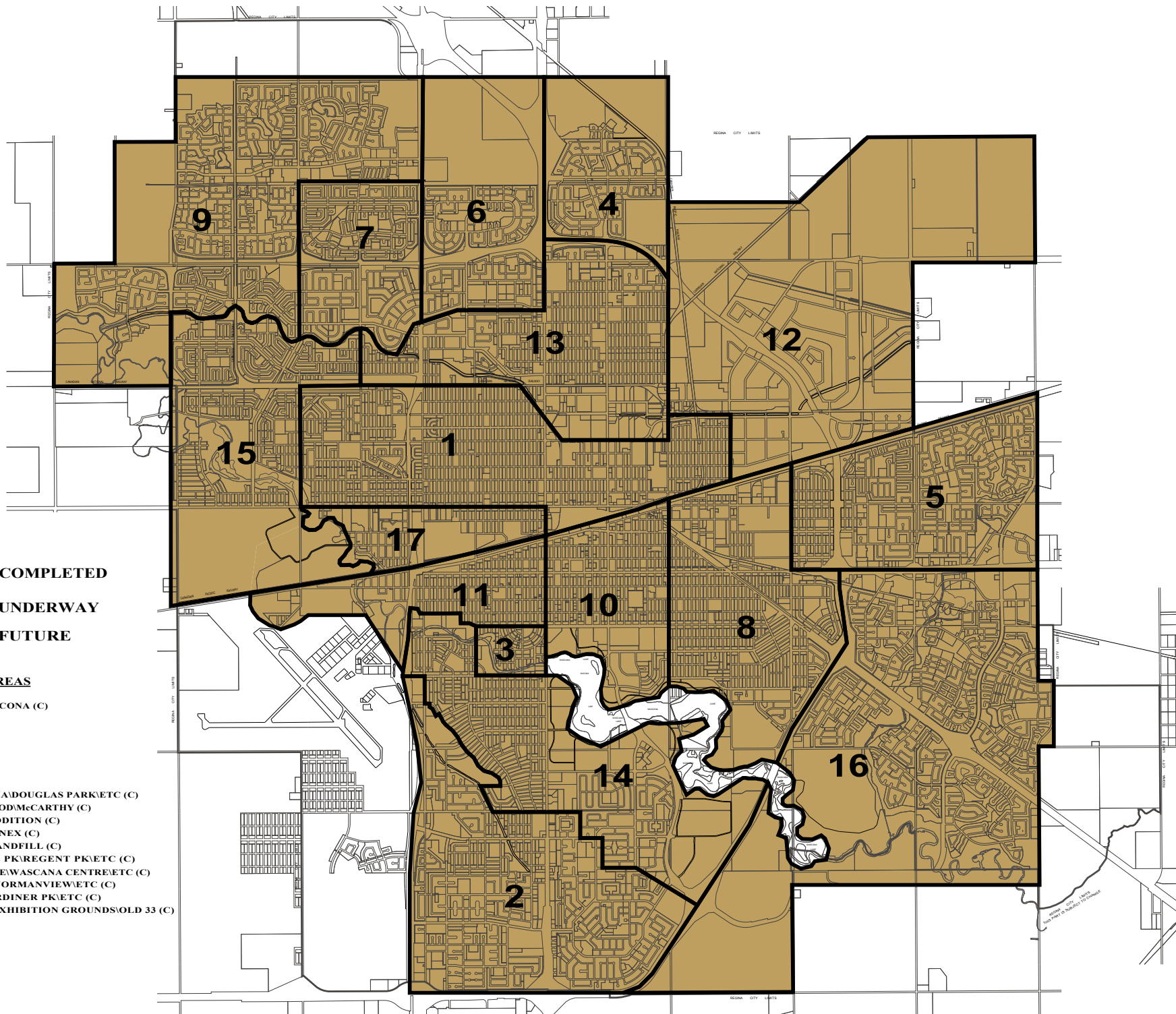

Drainage Studies

<u>Study Area</u>	<u>Study Status</u>
1. 7th Avenue	Completed
2. South Regina	Completed
3. Riverside	Completed
4. Uplands	Completed
5(a) Glencairn - South Section	Completed
5(b) Glencairn - North Section	Completed
6. Argyle Park	Completed
7. Walsh Acres	Completed
8. Arnheim/Assinboia/Douglas Park	Completed
9. Rochdale/Sherwood/McCarthy	Completed
10. Old 33/Wascana Addition	Completed
11. Cathedral/CPR Annex	Completed
12. Ross Industrial/Landfill	Completed
13. Old 33/Industrial Park/Regent Park	Completed
14. Lakeview/Hillsdale/Wascana Centre	Completed
15. Mount Royal/Dieppe/Normanview	Completed
16. University Park/Gardiner Park	Completed
17. Pioneer Village/Exhibition Grounds/Old 33	Completed
City Wide Study - Receiving Streams & Channels	To be completed in 2007

Most of the property damage caused in Regina during intense rainstorms has been the result of basement flooding. The flooding was caused by runoff water entering the wastewater collection system, resulting in sewer overload and back up into basements. Although the drainage system is separate from the wastewater collection system, there are a number of ways storm water can enter the wastewater collection system. These include:

- Some older buildings still have roof downspouts connected to the wastewater collection system.
- Runoff water on lots with poor grading adjacent to the building enters weeping tiles and collects in basement sump pits, which then drain into the wastewater collection system.

The City has established an objective to eliminate any direct connections between drainage and the wastewater collection system. An objective has also been established to reduce the runoff water entering the wastewater collection system from basement sump pits by educating homeowners about steps they can take to prevent such problems. In addition, a bylaw amendment that would prohibit weeping tile drainage discharge to the wastewater system in new development areas is under consideration.

The most well designed system cannot function effectively unless it is properly maintained. To ensure the system functions as designed, the following objectives have been established:

- Drainage lines over 450 mm are regularly inspected and cleaned as required.
- Catch basins in areas where leaves are a problem are typically cleaned every two years and outlying areas are cleaned on a seven-year cycle.

Dykes along Wascana Creek have been constructed and flood plains are maintained to contain creek flooding. The City's objective is to prevent major damage to property and maintain public safety in the event of flood conditions. Toward that end, monitoring is carried out during spring runoff to determine the risk of flood conditions and appropriate action is taken as necessary. The City has established an objective and capital plans to upgrade dykes to meet a 1:500 flood event level, the provincial standard. The upgrading of the dykes in Riverside was completed in 2005 and those in the Dieppe area will be completed in 2007.

Drainage System Maintenance

To identify and correct problems in the drainage lines, they are cleaned and inspected on average once every seven years. In conjunction with jet cleaning some lines are inspected by a closed circuit television camera.

Jet Cleaning Program Statistics	2002	2003	2004	2005	2006
Lines Cleaned (metres) (objective 54,987 m/yr)	73,410	58,605	60,620	50,693	22,993
Average Cost (\$/metre)	1.01	1.31	1.07	1.06	1.28

Drainage system lines requiring repairs are mostly identified as a result of the TV camera condition surveys.

Drainage System Maintenance Statistics	2002	2003	2004	2005	2006
Main Repairs (#)	8	4	4	2	2
Average Cost (\$/repair)	3,915	2,745	3,834	9,841	6,673
Manhole Repairs (#)	81	62	54	41	43
Average Cost (\$/repair)	596	728	678	788	932

Note: The increase in the average cost per repair for 2005 resulted because there were only two repairs, one of which was under concrete and had a relatively high restoration cost.

Since catch basins are designed to keep sand and other materials out of the drainage system, they require regular cleaning. Repairs to catch basins consist of raising or lowering the grates, replacing bricks and blocks, as well as replacing broken or missing covers. In addition, broken leads between the catch basin and the drainage lines are also replaced.

Catch Basin Statistics	2002	2003	2004	2005	2006
Catch Basin Repairs (#)	133	85	92	98	95
Average Cost (\$/repair)	656	766	767	574	775
Lead Repairs (#)	30	28	31	26	26
Average Cost (\$/repair)	2,676	2,905	3,077	2,679	2,638
Catch Basins Cleaned (#)	4,323	4,255	3,960	2,917	3,534
Average Cost (\$/catch basin)	31	27	24	31	37

Forecasting and Controlling Floods

Flood conditions on Wascana Creek are relatively rare. In 1996, high snowfall caused flood conditions along the creek. Creek flows were projected to be 85 cubic metres per second, or a 1:30 year flood. Although the actual peak levels were not as high as the initial predictions, it was necessary to take preventative action. Costs were incurred for labour and equipment for sandbagging and pumping water out of flooded areas, as well as repairs for some City owned structures damaged along the creek, such as the Pinkie Road Bridge. In 1999, flood control costs were incurred as a result of a large snow accumulation late in the winter, followed by a very quick spring thaw. The estimated creek flow was 40 cubic metres per second, or a 1:10 year event.

Forecasting flood conditions involves communicating with provincial agencies regarding snow volumes and predictions for spring thawing. Early in the year, Saskatchewan Watershed Authority conducts assessments of the snow cover in the Wascana Basin, as well as other areas around Saskatchewan. If the conditions warrant further concern, additional monitoring takes place. As the spring thaw begins, water flows are measured throughout the creek system.

Budgets are prepared assuming spring runoff levels of an average year, where no special flood control measures are required like sand bagging and pumping behind the dykes when drainage line outlets are closed. The budget covers the cost of monitoring conditions on Wascana Creek and the drainage channels, as well as putting up barricades in areas where thin ice and water levels could pose a danger to the public.

Home Flood Protection Education Program

This program informs homeowners about the causes of basement flooding and the measures they should undertake on their property to prevent flooding damage from intense summer rainstorms. The program involves media advertising, door to door contact, an information trailer, display of a physical model of a typical home illustrating flood protection measures, flood protection classes, a mail out home flood protection education kit and City Page internet flood proofing information. Flood proofing measures on private property are the parallel component of the storm drainage upgrading program. Mitigation measures are required on both City and private property to accomplish neighbourhood service level improvements for managing large summer storm events and minimizing property damage and risk.

The program is concentrated between June and September during the time when most severe summer rainstorms occur and the public interest in drainage mitigation measures is greatest.

In 2006, direct contact was made with 288 homeowners and program information was provided to 635 other homes. All homes were provided with a Home Flood Protection guide at a minimum. The Home Flood Display was presented and manned at four home supply centres with a total of 163 visitors. 124 Home Flood Information Kits were handed out or mailed to residents in 2006.

The Home Flood Protection model was displayed at the RRHBA Home and Garden Show, the Canadian Public Works Association Conference and the Engineering and Works Department Open House.

Engineering and Operations Administration

The majority of the information regarding water, wastewater and drainage services is provided in the preceding sections. The operating budget summary includes costs related to Engineering and Operations Administration.

Objectives for the planning, design, operations and maintenance engineering include:

- **Long Range Planning** – In order to meet customer demands, water, wastewater and drainage systems require high levels of capital investment. It is necessary to anticipate and plan for future requirements so that the necessary future investment can be provided. To accommodate this, the following objectives have been established:
 - Long range plans (20 to 25 years) should be carried out regularly for each of the three major utility systems.
 - Ongoing conditions should be monitored and the long range plans updated as new information becomes available.
- **Effective Management of Capital Program** – The Engineering and Works Department provides planning and design engineering services for the Utility. All capital projects should be completed within their established timelines and budgets.
- **Establishment of Construction Standards** – Standards are developed for all infrastructure construction, including those relating to the utility systems. These standards are applied to construction carried out by City crews, contractors and developers. Over time, standards evolve as new construction techniques and materials become available. The objective of these standards is to optimize performance and minimize the life cycle cost for the provision of the services.
- **Public Education** – There are a number of areas within the utility operations where customer actions can collectively affect service and costs. Areas where it is desirable to change customer behaviour, such as the manner in which they use the systems, are regularly identified. Public education is then carried out in an effort to change customer behaviour. General awareness is also considered part of public education and is run as a program when required. Current programs include:
 - Water Conservation
 - Cross Connection Control and Backflow Prevention
 - Home Flood Proofing
 - Creekwatch
 - Wastewater Discharge Practices

Engineering and Project Management

The Water, Engineering, Wastewater and Drainage Section, Environmental Engineering Section, and Development and Technical Services Division of the Engineering and Works Department and operations engineering staff are responsible for planning, designing and supervising construction of the Utility systems infrastructure. A primary responsibility is overseeing the annual capital program. Projects carried out range from annual infrastructure renewal projects to less frequent major projects such as water treatment or wastewater treatment plant expansions. Engineering and design work may be done in-house or by an external engineering firm. Construction work may be done by Engineering and Works Department crews or by external contractors. The resources used for projects depend upon the nature of the project, the availability of resources, and the expertise required.

Environmental Monitoring

Environmental monitoring activities include:

- Ground water monitoring at the sewage treatment plant.
- Surface water quality monitoring in the City's four retention lakes.
- Stormwater quality monitoring of urban drainage discharge to Wascana Creek and Wascana Lake.
- Snow dumpsite runoff monitoring.

Review of Development Proposals

Much of the City's water, wastewater and drainage systems are constructed by City forces, or by contractors under the direction of City staff. In the case of new development and re-development of existing areas, developers are responsible for constructing infrastructure including water, wastewater and drainage systems. This construction forms part of the utility systems, and the City assumes responsibility for operation and maintenance of the systems.

Development proposals are reviewed by Engineering and Works to ensure design and construction meets City standards. Installations that do not meet City standards are identified and corrected by the developer.

Technical and Engineering Support

Engineering and Works Department technical and engineering staff provide support to the field personnel responsible for maintaining the water, wastewater and drainage systems, and for carrying out capital construction work for projects done in-house.

In addition, staff provide construction scheduling, construction coordination and administrative and technical construction management services, which includes:

- Establishing, monitoring, and updating construction schedules.
- Coordinating construction with utility companies.
- Tracking and monitoring expenditures of various capital projects.
- Estimating the costs of water and sewer construction projects.
- Reviewing and analyzing unit cost information.

Customer Billing and Collection

Initiatives for 2007

- **Utility Billing System Upgrade** – The customer information system used by the City was implemented in 1994, and had its last major upgrade in 1999. The project to upgrade the Indus Advantage CIS system was approved through the Information Systems project approval process. Since the versions of the software, operating system and database are currently unsupported, this upgrade is a very high priority for the area. This upgrade will result in a fully supported system. As part of the implementation, a number of smaller system-related initiatives are being reviewed. It is expected that a number of initiatives will no longer be required as a result of changes to the system, while others will be incorporated into the upgrade. Any system initiatives that have not been addressed through the upgrade will be reviewed and dealt with after the completion of the project.
- **Rate Review** – The current rate structure, which was set in 2004, established rates for the period 2005 – 2007.

In 1995, an extensive review of the water and sewer utility rates and rate structure was conducted. The review began by establishing the following objectives to guide rate setting for the utility in the future:

- Financial Sufficiency - Water and sewer utility rates must generate revenues adequate to meet all operating and capital costs of the utility in both the short and long term.
- Conservation - Water and sewer utility rates should encourage customers to use water responsibly.
- Reduction of Peak Demand - The water and sewer utility rates should modify peak demand, reducing the need for infrastructure investment.
- Equity - The water and sewer utility rates should result in a charge to customers according to the cost of services they utilize.

A new set of rates must be developed according to these principles for the next rate period of 2008 – 2010. Some of the factors that must be reviewed include: establishing rates at a level that will support the requirements of the 20 year utility model, in conjunction with appropriate debt issue; evaluating alternative rate structures, such as rate blocks, which will support the objectives outlined; and assessing alternative methods of charging for storm drainage.

Status of 2006 Initiatives

- **Re-sequencing of Water Meter Routes** – The meter reading routes currently used were originally designed to accommodate walking routes. With the implementation of the automated meter reading system (AMR) the established meter reading routes were no longer the most efficient use of staff time. A large-scale change was required to re-order the meters into new routes. In April 2006, a team made up of Utility Billing staff with support from Engineering and Works, Customer Service, and Sensus Metering Systems completed the re-sequencing project. The project was completed on time and under budget and positioned the Utility Billing area to move forward with monthly billing.
- **Landlord Agreement** – Landlords may enter an agreement with the City to assume responsibility for billing whenever a tenant moves out. The service fee is then waived for the landlord. This also ensures that the water service is not disrupted. In 2006, all existing Landlord Agreements were reviewed to ensure that they were still up to date, and customers were contacted to provide updates where necessary.

- **Monthly Billing Study** – Monthly billing was reviewed and a report provided to City Council recommending the implementation of monthly billing. Moving to monthly billing supports the City’s commitment to deliver services that meet the needs and expectations of customers. In addition, this change brought the City’s utility billing into alignment with other utilities. Monthly billing was implemented as of January 1, 2007.

Customer Service

The Revenue Administration and Assessment Department’s priority is providing customers with an exceptional level of service. This priority is applied to all aspects of operations, especially in contact with external customers, but also in dealings with internal customers and in responses to questions and requests for information. Objectives for customer service include:

- Customer applications for water services and disconnections are handled accurately.
- Customers can access information about their bill and receive prompt responses to their inquiries.
- Payments can be made using convenient payment methods.
- All service requests are processed within a reasonable time frame, given the nature of the service required.

Customer call centre volumes are monitored to ensure key performance indicators (KPI) are being met. The two primary KPIs are that calls are answered within 25 seconds, 75% of the time, and that abandoned calls are kept below 5%.

Customer service is accessible by telephone, mail, fax, in-person and electronically via the City website. Internet requests and e-business inquiries continue to increase and this continues to be an area of focus. Continued awareness of customer needs to access information and services quickly and efficiently in the manner of their choosing is the focus of customer service efforts.

The Division’s one-stop shop approach provides customers with information relating to the Division’s services through one central contact number. By directing customer calls to the area concerned, staff ensure that the customer is dealt with effectively and efficiently at their first point of contact.

The Division strives to ensure customer satisfaction on every occasion in the five essential elements of service: timeliness, knowledge and competency, courtesy, fair treatment and final outcome. When all five of these elements are in place, customers rate the services provided highly. The goal of the customer service area is to ensure satisfaction in every one of these areas with every customer.

The Division concentrates on establishing, exceeding and reviewing the needs and expectations of customers. The goal is to ensure that appropriate access to service is provided and that customers are informed of how and where to find the services they need. The Division is committed to “getting it right the first time, every time”.

Customer Service Statistics	2002	2003	2004	2005	2006
Calls Offered (#) ⁽¹⁾	101,367	100,943	94,358	84,930	88,830
Calls Answered (#)	95,875	93,907	89,243	79,781	81,079
Calls Abandoned (%)	4%	5%	4%	5.2%	6.5%
Cashier Utility Transactions (#)	45,727	46,043	45,269	41,551	43,787

Note 1: Total calls offered cover the services of Utility Billing, Property Assessment, Property Taxation, Parking Tickets, Animal Control and any other services provided by the Revenue Administration Division.

Administration, Billing and Collection

Objectives for billing and collection include:

- As of 2007, customers are billed every month.
- Customers receive accurate and timely, and informative bills.
- New payment methods are introduced where they can provide convenience to the customer, and where they are cost effective.
- Collection action is taken as required.
- Percentages of overdue accounts and uncollectible accounts are at a reasonable level.

The administration of customer accounts and the billing and collection function includes:

- Managing customer accounts, including setting up new customers, discontinuing accounts and transferring accounts from one individual to another. There is also a requirement to manage contracts with out-of-town water users who receive water from the City.
- Managing activities related to water meters includes obtaining meter readings and handling turn ons or turn offs of water lines. Customers are divided into automated meter-reading routes so the meters are read accordingly to a monthly schedule.
- Water services must be connected and disconnected in response to customer requests and as a result of collection efforts. The following table provides information on the number and reasons for turn offs and turn ons.

-

Turn On/Turn Off Statistics	2002	2003	2004	2005	2006
Daytime Turn Ons (#)	1,682	1,511	2,035	2,338	2,076
Daytime Turn Offs (#)	1,973	1,997	2,486	2,568	2,270
Turn Offs Due to Arrears (#)	447	612	893	1,053	1,109
Total	4,102	4,120	5,414	5,959	5,455

- Generating customer bills – Customers are divided into billing cycles so each customer is billed every month. One billing cycle is processed each working day.
- Collection efforts take many forms. Interest is added to outstanding balances, which encourages timely payment. When accounts remain outstanding, payment arrangements are negotiated where possible. This includes maintaining a post-dated cheque database, as well as providing equalized payment options for utility accounts. The following table provides a summary of the utility accounts outstanding as at December 31, 2006.

Utility Receivables - December 31, 2005

Analysis of Receivables	Amount Outstanding	Per Cent of Total
0-30 Days	\$ 4,673,865	68.8
31-90 Days	820,014	12.1
91-150 Days	359,330	5.3
151-365	450,884	6.6
>365 Days	489,155	7.2
Total	<u>\$ 6,793,248</u>	<u>100.0</u>

Collection efforts are not always successful. Provincial legislation provides the authority to enforce payment. There are a variety of options available which include: discontinuing utility service, transferring outstanding utility balances to the tax roll if the account is with the property owners or placing the account with an external collection agency.

When a Utility account enters delinquency, it follows one of two paths. If the account holder can be identified as an owner on the tax roll, the account is subject to a tax transfer. If the account holder is not the property owner the account is subject to disconnection. Virtually all of the accounts identified as "owner" accounts will be collected through the tax transfer. For "renter" accounts, the City has good success in collecting outstanding charges through disconnection of service, as long as the account remains active. Typically, if this option is pursued, the customer either provides payment or enters into adequate payment arrangements. When a customer moves without notifying the City, the success rate of collecting outstanding balances decreases. Once the customer account is inactive, the account is transferred to a collection agency. In most cases, the customer will have two or more bills outstanding at that time.

If a customer with an account from an old address moves to a new address, the City requires payment or acceptable payment arrangements immediately. For those accounts where the customer does not move to a new location with an account, the success rate for collection is greatly reduced. Also, these accounts do not have a high rate of success when placed with a collection agency.

In 2005, deposits were implemented for accounts where the customer does not match the tax roll, and where the customer does not have an established good payment history. It is anticipated that deposits will significantly reduce the annual write-offs due to bad debts.

Debt Costs

This program includes the cost of principal and interest for debt issued to finance utility capital projects, along with the cost of the debt issue. Debt charges are made up of two elements:

- Interest – This is the cost of interest payments on all outstanding serial debentures.
- Principal repayments – These payments represent the cost to redeem the principal portion of a serial debenture that matures each year. A serial debenture does not remain outstanding in full for the life of the debt issued. As with a mortgage, a portion of the principal amount of the debt matures and is paid each year until the debt is fully mature.

The following table shows the existing annual debt charges and debt maturities.

Schedule of Debt Charges and Debt Maturities (\$000's)

Year	Annual Debt Charges	Debt Maturities		Cumulative Percentage Reduction
		Debt Maturing	Per Cent of Total	
2007	\$ 10,546.0	\$ 8,900	25.9%	25.9%
2008	7,167.0	5,900	17.2%	43.0%
2009	5,612.0	4,600	13.4%	56.4%
2010	5,384.0	4,600	13.4%	69.8%
2011	5,145.0	4,600	13.4%	83.1%
2012	4,898.0	4,600	13.4%	96.5%
2013	646.0	600	1.7%	98.3%
2014	616.0	600	1.7%	100.0%
	Total	34,400	100.0%	

The 2007 – 2011 Utility Capital Program requires external debt financing of \$35 million in 2009, \$15 million in 2010 and \$50 million in 2011. The utility model includes funding for debt issuance costs and the repayment of projected debt issues based on a ten-year term and an interest rate of 6%.

Utility Capital Program

Capital Program Summary

	2007	2008	2009	2010	2011	Five Year Total
Capital Expenditures (\$000's)						
Water Supply, Pumping & Distribution	3,580	4,890	4,640	5,640	11,290	30,040
Wastewater Collection & Treatment	7,420	14,190	42,835	21,455	54,145	140,045
Drainage	4,470	3,455	4,860	5,450	3,800	22,035
Total Expenditures	15,470	22,535	52,335	32,545	69,235	192,120
Capital Funding (\$000's)						
General Utility Reserve	12,954	19,151	13,896	14,474	12,529	73,004
New Debt	-	-	35,000	15,000	50,000	100,000
Municipal Rural Infrastructure Fund ⁽¹⁾	1,700	1,700	1,700	1,700	1,700	8,500
Utility Development Charges	816	1,600	1,459	1,133	2,710	7,718
City of Moose Jaw	-	84	280	238	2,296	2,898
Total Funding	15,470	22,535	52,335	32,545	69,235	192,120

Note 1: The current program expires at the end of 2008. It is assumed to continue in 2009 to 2011 for purposes of financial planning.

Infrastructure Overview

Regina has a substantial investment in utility infrastructure. A challenge for Regina, and other cities, is to generate sufficient funds to maintain these assets. The gap between the annual requirement to sustain the infrastructure and the annual investment is referred to as the "Infrastructure Gap". Regina is a relatively young city and has to some extent been shielded from the full impact of its utility infrastructure deficit since, until recently, much of the buried infrastructure was still within its expected service life.

In recent years there has been increased discussion of the infrastructure deficit faced by cities, and the need for additional funding from the senior governments and/or alternate revenue sources for cities. The Federal Government has implemented a "new deal" for cities. Components of the new deal include funding for infrastructure programs and a sharing of the federal gas tax. In 2004, the Federal Government revised the policy for GST rebates to provide a full rebate to municipalities. The Municipal Rural Infrastructure Fund (MRIF) started in 2005 and continues through to 2008. Regina's share of the funding is about \$6.8 million in total or about \$1.7 million per year over the four years. The 2005 Federal Budget provided a share of the federal gas tax to municipalities. Regina's share is about \$4.4 million in 2007, \$4.5 million in 2008, and increases to \$11.1 million in 2009. Issues related to the funding include:

- Funding received by Regina through senior government grant programs is directed to general and utility capital projects. To the extent that funding is used for utility capital projects, an equivalent amount is transferred from the Water and Sewer Utility to the General Capital Program. The utility budgets have been developed based on the utility receiving the full grant allocation for the Municipal Rural Infrastructure Program with an equal amount transferred to the General Capital Program. There is no gas tax funding currently projected to be used to fund utility capital requirements. This will be reconsidered for the 2008 Budget.

- There will be increased funding available for transportation infrastructure, including roadways. Most of the utility infrastructure is under roadways. When roadways are re-developed, utility infrastructure is evaluated and upgraded if necessary. Increased funding for roadways will result in increased funding requirements for the Water and Sewer Utility.

In 2004, City Council approved the Residential Growth Study (Report CR04-196). Implementation of the Residential Growth Study will require integration of infrastructure requirements into sector and concept plans. These plans will detail the physical and engineering aspects of the new infrastructure along with funding and phasing of the work. Current development policies are based on the provision of trunk services uniformly throughout the city, with development charges, levied pursuant to *The Planning and Development Act*, the same for all newly developed land, irrespective of location. The development scenarios adopted in the Residential Growth Study result in significantly different trunk infrastructure requirements, and hence infrastructure costs, for each of the growth areas. The intent is to implement changes in development charge rates that address the differences in infrastructure costs.

Section 22.4 of *The Cities Regulations* requires Council to adopt a capital investment strategy that includes the method used for determining capital plans respecting the waterworks. Capital requirements (capital investment strategy) are determined based on engineering and planning studies that take into account the infrastructure requirements of the utility required to meet the service goals of the utility, as determined by City Council or prescribed by legislation. Infrastructure requirements are being addressed through a series of studies. Studies recently completed or underway include:

- The Wastewater Collection System Assessment Study, completed in 2004, estimated the replacement value of wastewater collection system as \$635 million. The study defined requirements for the long term sustainability of the wastewater collection infrastructure. In 2006, further work was done to investigate inflow and infiltration to the wastewater collection system.
- The review of the Long Term Water Utility Plan was completed in 2006. It examines the present condition of Regina's water system, forecasts the requirements for the next 20 years and provides a plan for meeting future requirements. A rough estimate of the replacement value for the water distribution system is \$250 to \$300 million, with a further \$350 to \$400 million for the supply system, including the City's share of the Buffalo Pound Water Treatment Plant.
- The 2007 budget includes funding, in partnership with the City of Saskatoon, for the development of a Buried Asset Repair Strategy. Approximately two-thirds of the water distribution and wastewater collection systems was constructed in a thirty-year period between the early 1950s and the late 1970s. In this period, almost all of the water distribution system construction used asbestos cement pipe. Asbestos cement pipe has a reliable service life, under the conditions that prevail in Regina, of 50 years. In recent years, there has been an increasing frequency in breaks in asbestos cement pipe. This pattern will likely continue as the system ages.
- The value and infrastructure requirements of the sewage treatment plant were documented through the Sewage Treatment Planning Study. The final report was completed in late 2005. The initial Wascana Creek Receiving Environment Study was also completed in 2005. Both studies were used in developing capital plans for the wastewater treatment plant upgrade and to develop future plans to create a receiving environment water quality model.

Once the studies are completed, the full scale of the infrastructure gap can be determined. The program presented in the 2007 – 2011 Capital Budget addresses infrastructure requirements identified to date, however, there are a number of outstanding renewal requirements that are likely to be identified as these studies are completed.

Water Supply, Pumping and Distribution

Capital Summary (\$000's)	2007	2008	2009	2010	2011
Capital Expenditures					
1. Water Supply:					
- System improvements	300	300	400	-	-
- New reservoir	10	-	-	-	-
- Pipeline swab structure	900	-	-	-	-
- Buffalo Pound pumping and controls	250	-	-	-	-
- Water reservoir upgrades and rehabilitation	200	-	-	-	-
- Buffalo Pound Water Treatment Plant Upgrade	-	300	1,000	850	8,200
- Albert Street Reservoir roof repair	-	50	250	1,700	-
2. Water Pumping - Pumping station improvements	-	50	-	50	-
3. Water Distribution:					
- Water infrastructure renewal	1,100	1,150	1,200	1,250	1,300
- Watermain upgrades and improvements	100	100	100	100	100
- Hydrant replacement	150	150	150	150	150
- New trunk watermains	330	300	300	300	300
- Water service line replacement	-	1,000	1,000	1,000	1,000
- Albert Street trunk watermain	-	1,000	-	-	-
4. Other Capital Projects:					
- Trench settlement remediation	100	100	100	100	100
- Capital project deficiency	140	140	140	140	140
- Bulk water loading system	-	250	-	-	-
Total Expenditures	3,580	4,890	4,640	5,640	11,290
Capital Funding					
General Utility Reserve	3,240	3,506	4,060	5,102	8,694
City of Moose Jaw	-	84	280	238	2,296
Development Charges - Utility	340	1,300	300	300	300
Total Funding	3,580	4,890	4,640	5,640	11,290

Water Supply

- System Improvements** – From 2007 to 2009, \$1 million is provided for repairing and replacing main valves, air release valves, valve structures and other miscellaneous work on the 900 mm Buffalo Pound to Regina pipeline. This pipeline is 50 years old and requires improvements to provide greater reliability for the water supply to the city and reduce the number of emergency repairs. A second pipeline was completed in 2003 to add capacity and reliability and reduce electrical energy requirements for the water delivery from the Buffalo Pound Water Treatment Plant to the city.
- New Reservoir** – The Long Term Water Utility Study Update has identified additional reservoir capacity as being needed to address long term water demands and to meet regulatory requirements. Additional reservoir capacity is not required until 2021. In 2007, funding of \$10,000 is provided to determine the location of a future reservoir at the intersection of Lewvan Drive and 9th Avenue North. This work will be done in conjunction with the update to the functional design of the interchange.
- Pipeline Swab Structure** – This funding is for the design and construction of a swab retrieval structure to allow swabbing of the 1,050 mm. pipeline from the Buffalo Pound Water Treatment Plant to the City. The swab launch structure was constructed previously. Planning has now been completed to finalize the location of the swab retrieval structure.

- **Buffalo Pound Pumping and Controls** – Funding is required to complete the installation of new pumps and control valves at the Buffalo Pound Water Treatment Plant early in 2007. With the completion of new pump installations early in 2007 and the supply pipeline twinning project in 2003, pumping capacity will increase from 125 to 165 million litres per day to meet present and future peak day water requirements.
- **Water Reservoir Upgrades and Rehabilitation** – This funding is to upgrade and rehabilitate the existing five water reservoirs as required. This includes repairs to the concrete structure, vents, hatches, ladders, piping, roofs, etc. to maintain reservoirs in good condition.
- **Buffalo Pound Water Treatment Plant Upgrade** – The Long Term Water Utility Study Update recommended upgrades be considered at the Buffalo Pound Water Treatment Plant. These upgrades include protozoa reduction, disinfection by-products control and residuals management. Detailed water sampling and testing will begin in 2007, with engineering for process improvements starting in 2008 and construction starting in 2011.
- **Albert Street Reservoir Roof Repair** – This provides funding for the repair of the Albert Street Reservoir which was built in 1930. Engineering inspections have confirmed that the structure is deteriorating very slowly and that it can be repaired more economically than being replaced.

Water Pumping

- **Pumping Station Improvements** – \$50,000 is provided in 2008 and 2010 for the addition of new equipment and replacement of obsolete equipment to improve the operation of the pumping stations.

Water Distribution

- **Water Infrastructure Renewal** – \$1,100,000 is provided in 2007 and \$4.9 million for the balance of the five-year program. This program is for replacement of deteriorated watermains and associated fire hydrants. Work is scheduled in conjunction with other infrastructure replacement and upgrading projects. In 2007, asbestos-cement watermains with chronic break problems will be addressed. A high frequency of breaks in old watermains results in high maintenance costs, deterioration of streets and sidewalks and loss of service for water customers. A joint project with the City of Saskatoon will identify long and short term strategies to address the increasing break frequency through optimizing investments. A cast iron watermain replacement program was adopted by City Council in 1979 and completed in 2001 for the replacement of full blocks of cast iron watermains. This program significantly reduced the number of watermain breaks experienced each year. Replacement of full blocks of cast iron watermains was completed in 2001. Remaining cast iron watermains in intersections are being replaced in conjunction with roadway renewal projects.
- **Watermain Upgrades and Improvements** – \$100,000 is provided in each year of the five-year program to eliminate, where possible, dead-ends on watermains. Where dead-ends cannot be eliminated, a flush out is provided to allow thorough flushing of the watermain. The project is intended to eliminate water quality problems caused by dead-ends and ensure the best practical water flows to fire hydrants for fire protection. Based on current funding levels, this initiative will be completed in approximately ten years.
- **Hydrant Replacement** – \$150,000 is provided each year to replace old fire hydrants at locations where streets and sidewalks are being replaced, and to replace hydrants that can no longer be repaired. Fire hydrants are also replaced through the water infrastructure renewal program. If required, emergency replacement of malfunctioning hydrants is funded in the operating budget. There are 3,991 hydrants in the city. Malfunctioning hydrants beyond repair are replaced

immediately. Obsolete slide gate hydrants are replaced with compression style hydrants. At this time, 658 hydrants have been identified for replacement. Where possible, fire hydrant replacements are coordinated with other infrastructure improvements, such as watermain upgrades or renewals.

- **New Trunk Watermains** – Trunk watermains are required to supply new neighbourhoods in the NW, SW and SE sectors. The City provides an “oversize watermain” rebate for watermains which are 250 mm and larger in diameter. The timing of construction is determined by the developer. For 2007, \$300,000 is required for the Pasqua Street main and \$30,000 is required for the Houghton Road main.

Other Capital Projects

- **Trench Settlement Remediation** – \$100,000 is provided each year to correct settlement at watermain replacement locations. Cracking and settling of sidewalk, curb, gutter and pavement occur as a result of backfill settlement at watermain work locations, resulting in drainage problems.
- **Capital Project Deficiency** – \$140,000 is provided each year to address deficiencies in past capital works. Of the total, \$35,000 is allocated for Drainage, \$35,000 for Wastewater Collection and Treatment and \$70,000 for Water Supply, Pumping and Distribution. The funding is used to repair asphalt and concrete deficiencies that result from underground utility construction. The deficiencies are repaired between two and five years after the project is complete. Typical deficiencies are sidewalk settlement, pavement failures, landscape problems and drainage problems. In conjunction with the trench settlement remediation project, the City undertakes about 17 repairs each year. Approximately 160 locations have been identified as requiring work.

Wastewater Collection and Treatment

Capital Summary (\$000's)	2007	2008	2009	2010	2011
Capital Expenditures					
1. Wastewater Collection:					
- Trunk main upgrading	1,400	1,070	570	1,070	570
- Pumping station upgrading	500	250	700	250	700
- Manhole upgrading	20	320	220	320	220
- Infrastructure renewal	2,400	2,600	2,800	3,000	3,200
- New Infrastructure	375	-	-	-	-
2. Wastewater Treatment:					
- McCarthy Pump Station upgrading	-	2,700	-	-	-
- Upgrade forcemain - McCarthy Pump Station to Sewage Treatment Plant	-	500	8,800	-	-
- Wastewater treatment plant expansion	2,025	6,000	23,180	16,665	48,205
- Wastewater treatment plant improvements	550	-	2,310	-	1,100
- Wastewater treatment plant refurbishing	150	750	2,930	150	150
- Waste hauler station development	-	-	1,325	-	-
Total Expenditures	7,420	14,190	42,835	21,455	54,145
Capital Funding					
General Utility Reserve	6,094	13,040	5,826	4,772	885
Debt	-	-	35,000	15,000	50,000
Municipal Rural Infrastructure Fund	850	850	850	850	850
Utility Development Charges	476	300	1,159	833	2,410
Total Funding	7,420	14,190	42,835	21,455	54,145

Wastewater Collection

- Trunk Main Upgrading** – \$4,680,000 is provided in the five-year capital program to undertake wastewater trunk system upgrading and refurbishing capital works that result from capacity and condition investigations conducted on the collection system trunks. In 2007 a section of the Wascana Valley Trunk wastewater main will be rehabilitated.
- Pumping Station Upgrading** – \$2,400,000 is provided in 2007, 2009 and 2011 for rehabilitating the York Street, Ritter Avenue, Maple Ridge and Mount Royal pumping stations. \$50,000 is provided in each of 2008 and 2010 to continue the installation of the new supervisory control and data acquisition (SCADA) system in wastewater pumping stations. There are a total of 16 wastewater pumping stations in the city. Since the early 1990's, six new stations have been constructed, three have been rehabilitated, and one phased out. One replacement station is being designed and four stations will be rehabilitated over the next five years. Two are in good condition and require no improvements at this time.
- Manhole Upgrading** – \$1,100,000 is provided in the five-year capital program. The funding provides for manhole infiltration control and manhole separation. Combined manholes that allow access to both the wastewater collection and drainage systems exist in a number of locations around the city. Such manholes can allow drainage water to enter the wastewater system causing overloading of the sewers, potentially resulting in basement sewer backup. Under this project, combined manholes are reconstructed to prevent the drainage water from entering the wastewater system. Infiltration control

involves implementing measures, such as new covers and seals, at wastewater manholes to prevent drainage water from entering. This capital expenditure will result in reduced operating expenses in treating drainage water.

- **Infrastructure Renewal** – \$14 million is provided in the five-year capital program to fund renewal of the wastewater collection system, including collection lines, catch basins, manholes and connections. This program will rehabilitate wastewater collection lines in conjunction with scheduled roadway renewal projects and at chronic repair locations to reduce the need for emergency repairs. Collection lines are surveyed by camera and the condition rated so that a program can be developed each year according to the needs. The general and utility capital budgets fund the renewal of their respective infrastructure components. This program rehabilitates wastewater infrastructure in conjunction with roadway infrastructure renewal and will require additional funding in future years as funding for roadway renewal is increased. **Funding of \$850,000 per year is projected from the Municipal Rural Infrastructure Program.**
- **New Infrastructure** – New trunk wastewater collection mains are required to serve newly developed areas of the City. Projects may be constructed by the area developer and cost shared with the City, or the City may construct the trunk watermain or forcemain. Timing of construction is coordinated with the developer involved. In 2007, \$375,000 is provided for the final section of the wastewater forcemain from the Southeast Sector Lift Station to the Arcola Avenue Trunkmain.

Wastewater Treatment

- **McCarthy Pump Station Upgrading** – \$2,300,000 is provided in 2008 to fund screening upgrade improvements at McCarthy Boulevard Pumping Station. The detailed engineering and construction will occur in 2008. All sewage from the wastewater collection system is pumped to the Wastewater Treatment Plant through this facility. An allocation of \$400,000 is provided in 2008 for upgrading station valves and major concrete maintenance.

The McCarthy Pump Station also is adjacent to residential neighbourhoods and odour from the facility results in complaints. Monitoring and characterization studies of the odour problem have been undertaken. A pre-design engineering study of odour abatement control and process options (estimated cost of \$50,000) is planned in 2007 utilizing previously approved funding.

The pump station also serves as a dumping station for sewage and liquid wastes collected from within the City and surrounding areas by commercial liquid waste haulers. Operation of the dump station creates local traffic problems and adds to the odour problems. Plans and finding options to re-locate the dump station to a new suitable location, possibly outside the city, have been discussed with the RM of Sherwood and will be developed further in 2007. An allowance of \$1,325,000 is provided in 2009 for this project.

- **McCarthy Pump Station to Sewage Treatment Plant Forcemain Upgrade** – The original 42" steel forcemain (one of two forcemains from McCarthy Pump Station to the Wastewater Treatment Plant) was constructed in 1958 and is in marginal condition. A detailed internal inspection of the line will be undertaken in 2007. An allocation of \$500,000 in 2008 is for detailed engineering for forcemain repair work. Funding of \$8,800,000 is included in 2009 for replacement of one forcemain and associated piping and valves. This cost is based on the STP Long Range Planning Study. Pre-design engineering will commence on this project in 2007 utilizing previously approved funding.
- **Wastewater Treatment Plant Expansion** – Expansion projects include major treatment plant changes to meet new regulatory requirements as well as provide expanded hydraulic and process capability to meet larger wastewater flows associated with future city growth. The regulatory requirements of the Province require the City to meet nitrogen reduction requirement by the end of 2011. The Federal requirements under *The Environmental Protection Act* and *The Fisheries Act*

require the City to develop and implement a pollution prevention plan that will result in reduction of ammonia toxicity in the final effluent discharged to the Wascana Creek/QuAppelle River system. The increased treatment requirements result in a need to replace the biological treatment plant. The investigations to date lead to a Biological Nutrient Removal Plant (BNR), which will meet all environmental requirements that the City is required to meet. The schedule is for pre-design work to commence in 2007 with final delivery and commissioning of an expanded and enhanced treatment plant in 2011. The total estimated projected cost is \$96.1 million allocated as follows:

- Pre-design engineering will commence in 2007. During this step the process options and treatment capacities criteria as well as more refined capital and operating costs are determined. The estimated cost for this phase of engineering is \$600,000 funded in 2006.
- UV Disinfection Process Improvements. The plant uses ultraviolet light for final effluent disinfection prior to discharge to Wascana Creek. An allocation of \$825,000 is in 2007 for expansion of capacity.
- \$1,200,000 for implementation of a methane gas utilization project. Currently 50% of methane generated from biosolids digestion is flared.
- Detailed engineering for the expanded and enhanced treatment plant will commence in 2008. During this phase of engineering detailed civil, mechanical, electrical and control systems designs and construction drawings are completed in preparation for contract tendering. The 2007 allowance for initiating the phase is \$6,000,000.
- Construction of the plant expansion is scheduled to commence in 2009 with completion and commissioning in 2011. The 2007 – 2011 capital program includes \$23.2 million in 2009 which includes an allocation of \$2,000,000 for a new maintenance building to provide space for maintenance services required for the new BNR Plant. Also, \$16.7 million will be required in 2010 and a further \$48.2 million will be required in 2011 for the BNR Facility. The schedule may be impacted by the results of the CCME initiative to establish a national policy for regulation of municipal wastewater effluent disposal across Canada. It is not likely that the CCME initiative will result in a reduced effluent discharge standard which would reduce overall cost. It is only the timing of such expenditures that might be affected.

The estimated costs are preliminary and will be refined through the pre-design and detailed engineering stages. Funding for the project includes \$101,000 in 2007, \$300,000 in 2008, \$1,159,000 in 2009, \$833,000 in 2010 and \$2,410,000 in 2011 from Utility Development Charges, as the enhanced and increased capacity of the new plant will accommodate increased flows from new development.

- **Wastewater Treatment Plant Improvements** – Funding of \$3.96 million is provided over the 2007 to 2011 period. The projects and proposed schedule are as follows:
 - \$550,000 in 2007 for energy recovery devices, road and landscape improvements, generator upgrade and control building/telephone system upgrade.
 - \$2,310,000 in 2009 for a grit removal process upgrade.
 - \$1,100,000 in 2011 for conversion of the existing tertiary clarifier building to expanded maintenance shop requirements.
- **Wastewater Treatment Plant Refurbishing** – The program provides funding for major maintenance projects that are beyond the regular operating and maintenance budget. Over the five year capital program, \$4,130,000 is provided as follows:

- \$600,000 in 2008 for replacing HVAC heat exchangers scum system renewal, sludge gallery valving replacements.
- \$2,780,000 in 2009 for major refurbishing of the traveling bridges in the primary sedimentation tanks.
- \$150,000 in each of 2007 to 2011 to undertake maintenance work to refurbish corroded concrete process piping and valves.

Drainage

Capital Summary (\$000's)	2007	2008	2009	2010	2011
Capital Expenditures					
1. Drainage System Upgrading:					
- Catch basin installations	50	200	200	200	200
- Drainage pumping station upgrading	2,400	100	100	100	100
- Drainage infrastructure renewal	1,700	850	2,400	2,800	3,200
- Dredging and lake shoreline maintenance	100	200	300	300	300
- Glencairn	220	2,025	1,600	-	-
- CPR Annex	-	30	110	750	-
- Albert Park	-	50	150	1,300	-
Total Expenditures	4,470	3,455	4,860	5,450	3,800
Capital Funding					
General Utility Reserve	3,620	2,605	4,010	4,600	2,950
Municipal Rural Infrastructure Program	850	850	850	850	850
Total Funding	4,470	3,455	4,860	5,450	3,800

Drainage

- **Drainage System Upgrading** – Drainage system upgrading projects involve major improvements to reduce flooding caused by melting snow and large summer rainstorms. The upgrading of drainage systems is in accordance with the priority identified in Drainage Area Studies. The 2006 to 2010 Capital Program includes approximately \$10 million in projects identified in the Drainage Area Studies. The total estimated work exceeds \$90 million. At current levels of funding completion of all remaining projects will take up to 50 years. Projects in the current capital program include:
 - **Glencairn Upgrade Projects** – Funding of \$220,000 in 2007 provides for detailed design and \$1,800,000 in 2008 for construction of the Stewart Russell Park detention site. The Victoria Avenue southwest quadrant detention site requires funding of \$225,000 in 2008 for detailed design and \$1,600,000 in 2009 for construction.
 - **Catch Basin Installations** – \$50,000 is provided in 2007 and \$200,000 in each year from 2008 to 2011. The funding provides for the installation of catch basins at various locations on streets and in easements where severe ponding is a problem. Based on past construction, the average cost per location is \$8,000. There are a number of locations on record where catch basins are required. Increasing the catch basin inventory will result in increased catch basin cleaning costs.
 - **Drainage Pumping Station Upgrading** – \$2,400,000 is provided in 2007 for upgrading and renewal of a lift station at the Ring Road and North Storm Channel. \$400,000 is provided from 2008 to 2011 for electrical and mechanical upgrades at various pumping stations.
 - **Drainage Infrastructure Renewal** – \$10,950,000 is provided in the five-year capital program. This program will replace substandard drainage system lines either in conjunction with scheduled reconstruction work or at chronic problem locations. Drainage lines are surveyed by camera and the condition rated so that a program can be developed according to the priorities in each year. The general capital and utility capital budgets fund the renewal of their respective infrastructure components. This program results in a reduction in the number of drainage system emergency repairs that must be completed each year. **Funding of \$850,000 per year is projected from the Municipal Rural Infrastructure Program.**

- **Dredging and Lake Shoreline Maintenance** – \$100,000 is provided in 2007 for dredging and shoreline improvements at the Lakeridge storm water detention lake. Dredging of storm channels, small creeks and retention lakes is undertaken to remove sediment, restore hydraulic capacity and improve storm water quality.

Utility Capital Funding

Funding for the Water and Sewer Utility Capital Program is primarily from the following sources:

- General Utility Reserve.
- Utility Development Charges.
- Federal Provincial Infrastructure Programs.
- Debenture Debt.

General Utility Reserve

The General Utility Reserve is funded through the operating surplus of the utility. Each year the utility generates a surplus, a portion of which is transferred to the general operating and capital budgets, with the balance transferred to the General Utility Reserve. The reserve is primarily used to fund capital projects, but is available should there be an operating shortfall. The following table provides a projection for the General Utility Reserve.

General Utility Reserve (\$000's)

	2007	2008	2009	2010	2011
Reserve Balance - Start of Year	9,797	5,815	2,346	5,886	10,107
Net Operating Surplus	8,972	16,310	20,534	21,608	20,425
Capital Program Requirement ⁽¹⁾	(12,954)	(19,779)	(16,994)	(17,387)	(20,878)
Reserve Balance - End of Year	5,815	2,346	5,886	10,107	9,654

Note 1: The Capital Program Requirement reflects an estimated inflation rate applied to capital requirements. The 2007 – 2011 Utility Capital Program is presented in current dollars (without inflation). The utility model incorporates projected increases in revenues and expenditures due to inflation. The net operating surplus reflects future projected increases and as such, the inflationary projection for capital program requirements is also used in this table.

Utility Development Charges

Development charges are collected when a development agreement is entered into between the City and a developer. The agreements require a payment to the City of a predetermined amount per hectare of land within the development area. The funds are intended to be used towards the construction of infrastructure to support new development. Funds are not managed on a specific project by project basis because infrastructure demands related to new development do not necessarily occur only within the particular development. For example, each new development places some burden on wastewater treatment facilities and major arterials.

City policy determines the types of projects eligible for development charge funding and the percentage of eligible project costs.

In the case of roadways, water, and sewer costs for development, the City generally incurs the costs prior to the full development of an area. In other words, the costs are front ended. Parks and recreation infrastructure costs are generally incurred later in the process.

In 2006, a review of development charges including costs related to infrastructure to support new development was carried out. This review indicated that Regina's development charges, particularly for roadways and utilities, are not adequate to fund the costs of development. The rates have not kept pace with increases in the construction market, and do not reflect the extent of infrastructure that is necessary to support development in all areas of the City where new development is planned.

Furthermore, even if development charges were to be increased significantly, new development will place significant demands on the tax base to fund the non-developer portion of costs related to new development.

Effective January 1, 2007, development charges were increased by 17% to represent an inflationary factor. The increase does not represent the growing cost of the nature and type of infrastructure demanded by new development, such as interchanges and major new roads. Policies regarding development charges can play a significant role in shaping the City's development and in stimulating or encouraging growth. Proper management of this aspect of the City's finances and growth demands thorough review. To that end, a specialist firm with extensive experience in determining development charge rates and policies across Canada has been engaged to provide advice that will be brought to City Council for consideration in mid 2007.

The 2007-2011 Utility Budget has been developed recognizing the constraints in the existing development charge structure and in the limited funding available from utility reserve to support new development.

Very recent communications from the development community indicate that their plans for development propose earlier timing and phasing of construction than anticipated in this capital budget. In considering the Development Charges policy and rates and approvals of new development, City Council will have to consider various funding arrangements, such as negotiation of alternative cost sharing and developer front-ending.

Utility Development Charges are pursuant to *The Planning and Development Act, 1983* and are collected when development agreements are entered into between the City and a developer. The agreements require a payment to the City of \$24,443 per hectare of land within the development area. The payment of development charges is 30% upon execution of a servicing agreement, another 40% within nine months and the balance within a further nine months. Eligibility for funding is by policy of City Council and includes:

- 100% of funding for the cost of trunk watermains.
- A portion of the cost to construct watermains larger than 250 mm in diameter.
- 100% of funding for wastewater collection trunks which are 300 mm or greater in size.
- 100% of funding for wastewater lift stations that are a component of a regional servicing plan.
- 5% of the funding for expansion to the wastewater treatment plant for capacity for new development.
- 5% of the funding for McCarthy Boulevard pump station expansions, for capacity for new development.
- 100% of the funding for servicing design criteria review studies for the servicing of new land development.

- 100% of funding for drainage trunks 1,350 mm or greater in size.
- 100% of funding for drainage lift stations that are an approved component of a regional drainage plan.
- 100% of funding for a dry bottom detention facility (or the equivalent for a dry facility if a wet retention pond is constructed) if the pond is an approved component of a regional drainage plan.
- 100% of funding for new or upgraded storm channels that are an approved component of a regional drainage plan.
- 100% of the funding for full urbanization of the Pilot Butte and Chuka Creek adjacent to undeveloped lands if the improvements are part of an approved regional drainage plan.
- 100% of the funding for master drainage studies which are part of an approved regional plan of undeveloped land.

Revenue from development charges is recognized when the funds are spent on an eligible project. Historically, capital projects eligible for development charge funding have been undertaken ahead of the funds being available resulting in a shortfall in development charge funding. The projections for Utility Development Charges are detailed in the following table. The funding projections have been based on the development of 25 hectares in 2007 and 45 hectares per year from 2008 to 2011.

Utility Development Charges (\$000's)

	2007	2008	2009	2010	2011
Balance - Start of Year	(975)	(468)	(883)	(1,136)	(1,015)
Utility Development Charges ⁽¹⁾	1,323	1,233	1,295	1,359	1,427
Capital Program Requirements ⁽¹⁾	(816)	(1,648)	(1,548)	(1,238)	(3,050)
Balance - End of Year	(468)	(883)	(1,136)	(1,015)	(2,638)

Note 1: The projected utility development charges incorporate the approved rates for 2007, and increases in future years for inflation. The capital program requirements also incorporate projected increases due to inflation.

Federal Provincial Infrastructure Programs

The four-year Municipal Rural Infrastructure Program (MRIF) started in 2005, with \$1.7 million in funding available each year for Regina. City Council approved the allocation of the funding to Water and Sewer Utility projects in 2005 and 2006.

The recently announced 2007/08 Federal Budget has rolled the MRIF program into the "Building Canada Fund". Program criteria and allocations are not yet known. For purposes of developing the proposed Utility Capital Program the MRIF funding will be allocated to utility capital projects for 2007 and 2008, with the program to continue at the same level of funding in 2009 and 2010. As a result of the allocation of MRIF funds to the Water and Sewer Utility, there is a transfer of \$1.7 million per year from the utility to the General Capital Program.

Debt Financing

Section 135 of *The Cities Act* creates the authority to issue debt to finance capital projects. While debt is a source of capital financing, ultimately the cost of the debt (principal and interest) has to be funded through the utility operating budget. The following table is a summary of the outstanding debt and the debt maturing each year.

Schedule of Debt Maturities (\$000's)

Year	Debt Issues				Total	Per Cent of Total
	\$30 Million Feb 1997	\$13 Million May 1998	\$40 Million Nov 2002	\$6 Million May 2004		
2007	3,000	1,300	4,000	600	8,900	25.9%
2008	-	1,300	4,000	600	5,900	17.2%
2009	-	-	4,000	600	4,600	13.4%
2010	-	-	4,000	600	4,600	13.4%
2011	-	-	4,000	600	4,600	13.4%
2012	-	-	4,000	600	4,600	13.4%
2013	-	-	-	600	600	1.7%
2014	-	-	-	600	600	1.7%
2015	-	-	-	-	-	0.0%
Total	3,000	2,600	24,000	4,800	34,400	100.0%

In most instances, the debt issue in a particular year provides the debt financing required for several years of the Utility Capital Program.

In the 2007 – 2011 Utility Capital Program, debt requirements are:

- \$35 million in 2009.
- \$15 million in 2010.
- \$50 million in 2011.

The future debt requirements are based upon projected annual rate increases of 10% each year for 2008, 2009 and 2010. The future debt requirements are subject to change, as capital requirements in future years may change, the projected cost of requirements could change, or revenues generated from rate increases may change. In addition to the projected debt required to fund the 2007 – 2011 Utility Capital Program, based on current revenue and expenditure projections in the utility model, there are additional debt requirements beyond 2011. The graph on the next page shows projected utility debt levels incorporating the existing debt and the projected debt for 2008 through 2010.

Utility Debt Projections

